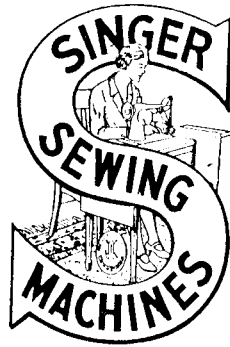


**SINGER**  
**111W115**

# LIST OF PARTS



## MACHINE No. IIIw115

THE SINGER MANUFACTURING COMPANY

## INDEX

	Page
Accessories .....	14
Bobbin Winder .....	14
Feed Dogs .....	16
Foot Lifter .....	17
Knee Lifter .....	15
Machine No. IIIw115 .....	5
Miscellaneous Parts .....	18
Numerical List of Parts .....	19
Presser Feet .....	16
Thread Unwinder .....	18
Throat Plates .....	17

From the library of: Diamond Needle Corp

# INSTRUCTIONS FOR ORDERING

In ordering from this list, use **ONLY** the PART number in the **FIRST** column.

The number stamped on a Sewing Machine Part is the number of the Single Part only, except when the part includes Set Screws, Clamping Screws, Studs and Rollers Spun on, Small Wires riveted, or Parts soldered together, etc., which it is necessary to furnish in combination.

Every combination of parts sent out has its specific number which, although not stamped on Parts (except in above case), must be used when ordering the combination.

Each number always indicates the **SAME PART** in whatever list it appears, or for whatever Machine.

The letters after some of the numbers indicate the style of finish only, as follows:

- A. Hardened, Polished and Plated.
- B. Polished and Plated.
- C. Hardened only.
- D. Polished only.
- E. Soft, not polished.
- F. Hardened and Polished.
- H. Blued.
- J. Nickel Plated only.
- R. Merlized.
- Y. Black Nickel Plated only.

These letters **MUST BE USED** when they appear in the list and **AFTER** the number, as in the list.

In this series

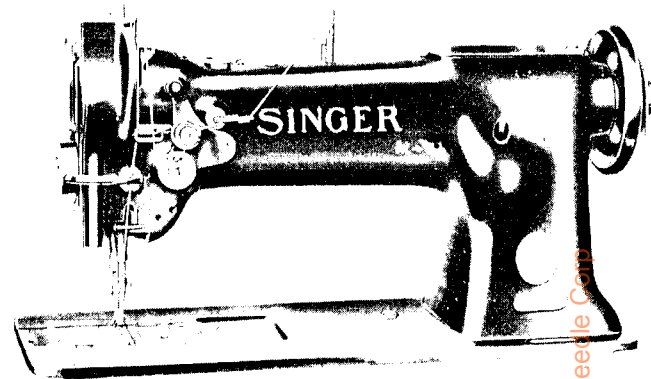
200001 to 201500 and 350001 to 351500 are Screw Numbers.  
 201501 to 201800 and 351501 to 351800 are Nut Numbers.  
 201801 to 202000 and 351801 to 352000 are Roller Numbers.  
 202001 to 350000 are Numbers of Machine Parts.

The figures in the second column refer only to the plate in which the illustration of the part is shown and are **NOT TO BE USED** in ordering.

Two or more numbers over a cut indicate that the difference between such parts is not visible in an illustration.

Parts marked with an asterisk (\*) are furnished only when repairs are made at the factory.

## LIST OF PARTS COMPLETE FOR



### MACHINE No. 111w115

HIGH SPEED. COMPOUND FEED. KNEE LIFTER.  
 ALTERNATING PRESSERS WITH 1/2 IN. LIFT.  
 SAFETY CLUTCH.

For Upholstery Work, Leather Coats, Binding Heavy  
 Felt Padding, Stitching Buff Wheels, etc.

No.	Plate	Name
*240002	-----	Arm with 202135
240069	14364	" Cap with 244071
244071	-----	" " Oil Wick
200278H	14327	" " Screw
202248	14327	" " Washer
204235	14327	" Position Pin (2)
200004E	14327	" Screw (3)
202005	14327	" " Washer (3)
240102	14365	" Shaft with 200357E and 224392
240802	14364	" " Bushing (back) with 202244
202244	-----	" " " " Oil Packing (wick)
200338C	14327	" " " " Set Screw
207080	14364	" " " (front) with 202244
202244	-----	" " " " Oil Packing (wick)
200502B	14327	" " " " " " Thumb Screw
200338C	14327	Arm Shaft Bushing (front) Set Screw
224103	14348	" " Connection Belt

From the library of: Diamond Needle Co.

No.	Plate	Name
224104	14364	Arm Shaft Connection Belt Pulley with 200327C, 200602E and two 202253
200602E	14327	Arm Shaft Connection Belt Pulley Position Screw
200327C	14327	Arm Shaft Connection Belt Pulley Set Screw
202253	14327	Arm Shaft Connection Belt Pulley Spring Flange
224113	14327	Arm Shaft Connection Belt Timing Collar with 200113F
200113F	14327	Arm Shaft Connection Belt Timing Collar Set Screw
224139	14327	Arm Shaft Connection Belt Timing Plate
200164B	14327	" " " " " " " Screw (2)
224392	-----	Arm Shaft Oil Packing (wick)
200357E	14327	" " " " Stop Screw
241561	14365	Balance Wheel (disc) (belt groove 2-3/4 in. diam.) with 200328C and 200335C
200328C	14327	Balance Wheel Position Screw
200335C	14327	" " Set Screw
*240103	-----	Bed
54897	14327	" Oil Cup
240003	14364	" Slide (back)
223811	14372	" " " Stop
223812	14372	" " " Spring
240004	14364	" " (front)
203470	14372	Bobbin
*233764	-----	" Case
203648	14372	" " Latch
*202056	-----	" " " Pin
203473	14372	" " " Plunger
203474	14372	" " " Spring
241674	-----	" " Oiling Felt
241675	14372	" " " Retainer
350405C	14372	" " " " Screw
224004	14372	" " Opener
224005	14372	" " " Lever with 201349C, 201542C and 203101
201349C	14372	Bobbin Case Opener Lever Driving Screw Stud
201542C	14372	Bobbin Case Opener Lever Driving Screw Stud Nut
203101	-----	Bobbin Case Opener Lever Driving Screw Stud Oil Packing (wick)
223622	14372	Bobbin Case Opener Lever Hinge Stud with 202277
202277	-----	Bobbin Case Opener Lever Hinge Stud Oil Packing (wick)
200364C	14372	Bobbin Case Opener Lever Hinge Stud Set Screw

No.	Plate	Name
223623	14372	Bobbin Case Opener Lever Link
200118D	14372	" " " Screw
203214	14372	" " Tension Spring
200984C	14372	" " " " Regulating Screw
200594C	14372	" " " " Screw
203216	-----	" " Washer (cloth)
233765	14372	Bobbin Case complete, Nos. 200594C, 200984C, 202056, 203214, 203216, 203473, 203474, 203648, 233764, 241674, 241675 and two 350405C
240179	14365	Face Plate
202135	14372	" " Position Pin
200473B	14372	" " Thumb Screw
240037	14364	Feed Bar
240038	-----	" " 240037 with 204052, 225837 and 350197E
350293C	14372	Feed Bar Hinge Screw (driving)
201518E	14372	" " " " Nut
264509	16580	" Dog, 40 elongated needle hole, for needle sizes 23 and 24
200106E	14372	Feed Dog Screw (2)
237565	14365	" Driving Connection with 200049D and 202330
201171C	14372	Feed Driving Connection Hinge Screw
201517E	16580	" " " " " Nut
202277	-----	" " " " " Oil Packing (wick)
202330	-----	Feed Driving Connection Oil Packing (wick)
200049D	16577	Feed Driving Connection Pinch Screw
237521	14364	" " Eccentric Regulating Bracket
237043	-----	" " " " " 237521 with 224108, two each 200256C and 201575E
224108	14364	Feed Driving Eccentric Regulating Bracket Flange with 200383C and 200437C
200437C	14368	Feed Driving Eccentric Regulating Bracket Flange Position Screw
200383C	14368	Feed Driving Eccentric Regulating Bracket Flange Set Screw
200256C	14368	Feed Driving Eccentric Regulating Bracket Hinge Screw
201525E	14368	Feed Driving Eccentric Regulating Bracket Hinge Screw Nut
202301	14368	Feed Driving Eccentric Regulating Bracket Plunger
237523	14368	Feed Driving Eccentric Regulating Bracket Plunger Spring

## PARTS FOR MACHINE No. IIIw115

No.	Plate	Name
200607C	14368	Feed Driving Eccentric Regulating Bracket Plunger Spring Stop Screw
200256C	14368	Feed Driving Eccentric Regulating Bracket Stop Screw
201525E	14368	Feed Driving Eccentric Regulating Bracket Stop Screw Nut
200429C	14368	Feed Driving Eccentric Regulating Screw
200383C	14368	" " " " " "
		Check Screw
223650	14348	Feed Driving Rock Shaft
240031	-----	" " " " 223650 with 201518E, 240038 and 350393C
223652	14368	Feed Driving Rock Shaft Crank with 200019E
200019E	14368	Feed Driving Rock Shaft Crank Pinch Screw
202625	14368	Feed Driving Rock Shaft Stop Collar with two 200383C (2)
200383C	14368	Feed Driving Rock Shaft Stop Collar Set Screw
224154	14368	Feed Lifting Cam with 201220C
224052	14368	" " " Fork with 200173D and 223655
350197E	14368	Feed Lifting Cam Fork Screw
225837	14368	" " " " " Washer
223655	-----	" " " " " Oiling Felt
200173D	14368	" " " " " " Screw
201220C	14368	" " " " " Set Screw
224122	14364	" Regulating Spindle with 202311, 202443 and 202619
*202311	-----	Feed Regulating Spindle Head
202443	14368	" " " " " Pin
202619	14368	" " " " " Position Pin
*240041	-----	Hook (sewing)
240042	14373	" 240041 with 203525, 224025, two each 200590H and 201253F
240207	-----	Hook and Bobbin Case complete, Nos. 233765 and 240042
224019	14368	Hook Bushing (lower) (bronze)
200364C	14372	" " " " " Set Screw
224020	14368	" " (upper) (bronze)
200446C	14368	" " " " " Position Screw
223867	13234	" Driving Gear (spiral) with 200362C and 201222C
201222C	13234	Hook Driving Gear Position Screw
200362C	13234	" " " " " Set Screw
240167	14373	" " Pinion (spiral with 200362C and 201220C
201220C	14368	Hook Driving Pinion Position Screw

## PARTS FOR MACHINE No. IIIw115

No.	Plate	Name
200382C	14373	Hook Driving Pinion Set Screw
224022	14373	" " " " Thrust Washer
240216	14365	" " " " Shaft
224111	14364	" " " " Bushing (back) with 202244
202244	-----	Hook Driving Shaft Bushing Oil Packing (wick)
237529	16576	Hook Driving Shaft Bushing (front)
200327C	14327	" " " " " Set Screw (2)
265314	16576	" " " " Lock Ratchet with 200354C and 200362C
200364C	14373	Hook Driving Shaft Lock Ratchet Position Screw
200362C	13234	Hook Driving Shaft Lock Ratchet Set Screw
240213	14373	Hook Driving Shaft Lock Stud
248423	14373	" " " " " Cotter Pin
240214	14373	" " " " " Socket
248425	14373	" " " " " Spring
240215	-----	Hook Driving Shaft Lock Stud complete, Nos. 240213, 240214, 248423 and 248425
203525	14373	Hook G1b
201253F	13234	" " " " " Screw
223850	-----	" Saddle with 200009E
224024	16576	" " 223850 with 200364C, 224019 and 224020
223681	16576	Hook Saddle Bearing
200335C	14327	" " " " " Set Screw
240018	16576	" " " " " Oil Guard
240019	-----	" " " " " Felt
200160D	14373	" " " " " Screw (2)
200009E	13234	" " " " " Pinch Screw
200006E	13234	" " " " " Screw
225585	13234	" " " " " Washer
240177	-----	Hook Saddle complete, Nos. 200118D, 200364C, 223622, 223623, 224004, 224005, 224022, 224024, 240167 and 240207
224025	14373	Hook Washer
200590H	14373	" " " " " Screw
208490	16579	Knee Lifter Connection Lever
200262H	14373	" " " " " Hinge Screw
223684	14365	" " " " " Lifting Rod with 202302
202302	13234	Knee Lifter Connection Lever Lifting Rod Cotter Pin
206628	14373	Knee Lifter Connection Lever Lifting Rod Spring
227227	14373	Knee Lifter Connection Lever Lifting Rod Spring Collar with 200113F

No.	Plate	Name
200113F	14327	Knee Lifter Connection Lever Lifting Rod Spring Collar Set Screw
240124	16579	Knee Lifter Lifting Lever
200262H	14373	" " " " Hinge Screw
240205	16580	Lifting Bell Crank
200996C	14373	" " " Cap Screw
240125	16580	" " " Link
350172C	16580	" " " " Screw Stud
201524E	16580	" " " " " Nut
240203	16579	" Eccentric with 200382C and 200398C
240126	16579	" " Connection
240171	16580	" " " Crank with 200029E and 210933
210933	-----	Lifting Eccentric Connection Crank Oil Packing (wick)
200029E	16577	Lifting Eccentric Connection Crank Pinch Screw
200398C	16580	Lifting Eccentric Position Screw
200382C	14373	" " Set Screw
240135	16580	" Presser Foot ,for cording and general upholstery
200074F	16218	Lifting Presser Foot Screw
240136	16579	" Rock Shaft with 201524E and 350172C
240174	16580	" " " Bushing (?)
264522	16579	Needle Bar with 200125F,200175D and 240170
202552	13234	Needle Bar Connecting Link
264718	16580	" " " " Oil Guard
200161D	16577	" " " " " Screw
202333	16577	" " " " Stud with 202254
202254	-----	Needle Bar Connecting Link Stud Oil Packing (wick)
200374C	13234	Needle Bar Connecting Link Stud Set Screw
200383C	14368	Needle Bar Connecting Link Stud Set Screw
208552	16580	Needle Bar Connecting Stud with 200086C and 202330
202330	-----	Needle Bar Connecting Stud Oil Packing (wick)
200086C	16218	Needle Bar Connecting Stud Pinch Screw
202692	16576	" " Crank with 200335C,200374C, 200383C,200428C and 202333
240178	-----	Needle Bar Crank 202692 with 202399, 202400,202552,208552 and 241518
203172	16577	Needle Bar Crank Friction Washer
200428C	16577	" " " Position Screw
200335C	14327	" " " Set Screw
264523	16579	" " Rock Frame

No.	Plate	Name
210910	13234	Needle Bar Rock Frame Hinge Stud with 202277
202277	-----	Needle Bar Rock Frame Hinge Stud Oil Packing (wick)
200347C	13234	Needle Bar Rock Frame Hinge Stud Set Screw
202666	16577	Needle Bar Rock Frame Position Bracket
200098F	16577	" " " " " " Screw
223690	-----	Needle Bar Rock Frame Rock Shaft
223691	14348	" " " " " " 223690 with 200387C and 210920
223692	16576	Needle Bar Rock Frame Rock Shaft Crank with 200029E
223693	16576	Needle Bar Rock Frame Rock Shaft Crank Connection with 202277
200837C	16577	Needle Bar Rock Frame Rock Shaft Crank Connection Hinge Screw
201522E	16218	Needle Bar Rock Frame Rock Shaft Crank Connection Hinge Screw Nut
202277	-----	Needle Bar Rock Frame Rock Shaft Crank Connection Oil Packing (wick)
200029E	16577	Needle Bar Rock Frame Rock Shaft Crank Pinch Screw
202668	16577	Needle Bar Rock Frame Slide Block
210920	-----	" " " " " " 202668 with 201141C
201141C	16580	Needle Bar Rock Frame Slide Block Screw Stud
200387C	16218	Needle Bar Rock Frame Slide Block Screw Stud Set Screw
240170	16580	Needle Bar Thread Guide
200175D	16577	" " " " Screw
200175F	16577	" Set Screw
208566	16579	Presser Bar with 200074F
241352	16581	" " Bushing (lower)
207072	16577	" " " (upper)
200352C	16580	" " " Set Screw (2)
264525	16579	" " Lifter
200653C	16577	" " " Hinge Screw
264526	16581	" " Lifting Bracket with 200054E
200975F	16577	Presser Bar Lifting Bracket Guide Screw
200054E	16581	" " " " Pinch Screw
202337	16577	" " Position Guide
202338	16577	" " " " Lever with 200086F
200086F	16218	Presser Bar Position Guide Lever Pinch Screw
200352C	16580	Presser Bar Position Guide Set Screw

No.	Plate	Name
237836	14365	Presser Bar Spring (flat)
210949	16218	" " " Bracket with 200086C
200086C	16218	" " " " Pinch Screw
201410F	16581	" " " Regulating Thumb Screw
200948F	16577	" " " Support Screw
265032	16218	Safety Clutch Hook Driving Shaft Position Collar with two 201254C
201254C	16218	Safety Clutch Hook Driving Shaft Position Collar Set Screw
265056	16218	Safety Clutch Locking Lever
265050	16218	" " " " Connecting Link
200993C	16218	Safety Clutch Locking Lever Hinge Screw
265035	16218	" " " " Spring
200962C	16218	" " " " Adjusting Screw
200092D	16218	Safety Clutch Locking Lever Spring Screw
265036	16576	Safety Clutch Pulley with 200962C and 202253
202253	14327	Safety Clutch Pulley Spring Flange
265057	16218	" " " Throw-in Latch
265052	16218	" " " " Pin
265051	16218	" " " " Spring
265040	-----	Safety Clutch complete, Nos. 200092D, 200993C, 265032, 265035, 265036, 265050 to 265052, 265056 and 265057
241518	14375	Take-up Lever
202399	16577	" " " Driving Stud with 202277
202277	-----	" " " " Oil Packing (wick)
202400	16577	Take-up Lever Hinge Stud with 202423
202423	-----	" " " " Oil Packing (wick)
200363C	16578	Take-up Lever Hinge Stud Set Screw
240023	14375	Tension Bracket with 201224B and 236060
200159F	16578	" " " Screw
234047	16581	" " " Socket
200368H	16581	" " " " Set Screw
240446	-----	Tension Bracket complete, Nos. 200978H, 201199F, 204271, 223438, 223703, 223704, 223706, 237174, 240023, two each 200309E, 201572B and 244048
244048	13234	Tension Disc
236060	16578	" " " Position Pin
223703	16578	" " " Release Lever
235576	16581	" " " " Rod
200309E	16578	" " " " Screw
223704	16578	" " " Plunger
264527	16581	" " " Slide

No.	Plate	Name
240142	16581	Tension Release Slide Spring
204271	16578	" " " Washer
223438	16578	" " " Spring
201224B	16578	" " " Stud
201572B	10881	" " " Thumb Nut
223706	16578	Thread Controller Disc
200978H	16218	" " " " Screw
237174	16578	" " " " Spring
242117	16581	" " " " Stop
200132E	16218	" " " " Screw
201199F	16578	" " " Stud with 204925
200061C	16578	" " " " Set Screw
201572B	10881	" " " " Thumb Nut
204925	16578	" " " " Washer
202412	16578	" " " Guide
224040	16578	" " " "
216955	16578	" " " (upper)
200582H	16578	" " " Screw (3)
241755	-----	" " Lubricator Oil Pad (felt)
237845	14362	" " " " " Holder
240439	14362	" " " " " Retainer
241758	14362	" " " " Reservoir
241759	-----	" " " " Wick
350280F	14362	" " " " Screw
214638	14362	" " " " Washer
237846	-----	Thread Lubricator complete, Nos. 214838, 237845, 240439, 241755, 241758, 241759 and 350280F
240034	16581	Thread Retainer
200355H	16578	" " " Set Screw
240144	14344	Throat Plate
691F	14362	" " " Screw (2)
240183	14362	Vibrating Presser Bar
240184	14362	" " " " Connecting Link
240185	14362	" " " " Extension with 204264 and 240186
240186	14362	Vibrating Presser Bar Extension Collar
204264	14362	" " " " " "
		Pin
202277	-----	Vibrating Presser Bar Oil Packing (wick)
240188	14362	Vibrating Presser Bar Spring
350299C	14362	" " " " Thumb Screw (pressure regulating)
240158	16580	Vibrating Presser Foot, 40 needle hole, with 201015F
201015F	14362	Vibrating Presser Foot Pinch Screw

## ACCESSORIES

No.	Plate	Name
200157B	16578	Attachment Screw
200861D	14362	Bed Slide (back) Locking Thumb Screw
203470	14372	Bobbin (5)
*225482	-----	" Case Screw Driver Blade
*225483	-----	" " " " Handle
225497	14334	Bobbin Case Screw Driver complete, Nos. 225482 and 225483
126 x 11	-----	Needles, six, size 24
231337	14362	Cloth Guide
200861D	14362	" " Thumb Screw
224121	-----	Drip Pan, 20 in. long, with four 1 in. wire nails
12361	14334	Machine Hinge Connection (2)
41400	14334	" Rest Pin (wood)
120342	14334	Oiler (copper plated) with 120343
120343	14334	" Spout, 3-1/2 in. long
*225484	-----	Screw Driver Blade
*225485	-----	" " Handle
225498	14334	Screw Driver complete, (7-1/4 in. long), Nos. 225484 and 225485
225554	14334	Wrench (steel)

## BOBBIN WINDER

(SWINGING AUTOMATIC, RIGHT HAND)

225453	10884	Frame with 202277 and 225438
225454	10884	" Hinge Pin
202277	-----	" Oil Packing (wick)
225438	10884	" " Well Cap
225455	10884	" Spring
225456	10884	" " Plunger
202473	10885	Pulley with 200380C
200380C	10884	" Set Screw
225381	10884	Spindle
225444	10884	Stop Latch
200056E	10884	" " Screw
225458	10884	" " Thumb Lever
225459	10884	" " " " Hinge Stud
225459	10884	" " " " Joint Stud
202478	10884	" " Trip Lever
200299H	10884	" " " " Hinge Screw

## ACCESSORIES

No.	Plate	Name
225461	10881	Tension Bracket with 201499B
200082D	10881	" " Screw
228026	10884	" " " Washer
2102	10881	" Disc
202407	10881	" Spring
201499B	10881	" Stud
201572B	10881	" " Thumb Nut
225462	10881	Bobbin Winder Tension Bracket complete Nos. 201572B, 202407, 225461 and two 2102
225433	10885	Bobbin Winder and Tension Bracket Base
225382	10885	Universal Bobbin Winder complete, Nos. 200056E, 200082D, 200299H, 202473, 202478, 225381, 225433, 225444, 225453 to 225456, 225458, 225462, 228026 two each 225459 and wood screws 3/4 in. No. 12, R. H. B.

## KNEE LIFTER

228294	15911	Rock Lever with two 356C
228295	15911	" " Bracket with 356C and four wood screws 7/8 in., No. 12
228299	-----	Rock Lever Bracket 228295 with 228294 and 228297
228296	15911	Rock Lever Extension with 200529C
356C	14362	" " " Set Screw
228297	15911	" " Hinge Pin
356C	14362	" " " " Set Screw
228284	15911	" " Knee Plate with 356C
202455	15911	" " " " Arm
356C	14362	" " " " Set Screw
356C	14362	" " " " Set Screw
227728	15911	" " Rod with 227729
*227729	-----	" " " Cap
200529C	15911	" " " Set Screw
228298	15911	Knee Lifter complete, Nos. 202455, 227728, 228284, 228296 and 228299

(Other Knee Lifter Parts are listed with parts of machine head.)

From the library of: Diamond Needle Co.



## FEED DOGS

No.	Plate	Name
240105	14344	Feed Dog,46 needle hole,for needle sizes 16 and 18,for 240143
240106	14344	Feed Dog,40 needle hole,for needle sizes 20 and 22,for 240144
240107	14344	Feed Dog,46 needle hole,for needle sizes 16 and 18,for 240144
240108	14344	Feed Dog,50 needle hole,for needle sizes 14 and 15,for 240144
240109	14351	Feed Dog,50 needle hole,for needle sizes 14 and 15,for 240145
240110	14351	Feed Dog,46 needle hole,for needle sizes 16 and 18,for 240145
240111	14351	Feed Dog,40 needle hole,for needle sizes 20 and 22,for 240145
240112	16580	Feed Dog,40 needle hole,for needle sizes 20 and 22,for 240144
264509	16580	Feed Dog,40 elongated needle hole,for needle sizes 23 and 24,for 240144

## PRESSER FEET

240128	14344	Lifting Presser Foot,for closing gloves, for 240150 to 240152
240130	14351	Lifting Presser Foot,for cording and general upholstery,for 240154
240132	14351	Lifting Presser Foot,for 240156
240133	14344	" " " " 240153
240134	14351	" " " " 240157
240150	14344	Vibrating Presser Foot,38 needle hole with 201015F,for closing gloves,for 240128
240151	14344	Vibrating Presser Foot,50 needle hole, with 201015F,for 240128
240152	14344	Vibrating Presser Foot,46 needle hole, with 201015F,for 240128
240153	14344	Vibrating Presser Foot,40 needle hole, with 201015F for 240133
240154	14351	Vibrating Presser Foot,40 needle hole, with 201015F,for 240130
240156	14351	Vibrating Presser Foot,46 needle hole, with 201015F,for 240132

No.	Plate	Name
240157	14351	Vibrating Presser Foot,40 needle hole, with 201015F,for 240134

## THROAT PLATES

240143	14344	Throat Plate,for 240105
240144	14344	" " " 240106 to 240108 and 264509
240145	14351	Throat Plate,for 240109 to 240111

## FOOT LIFTER

### Parts Required for Changing from Knee Lifter to Foot Lifter

223733	16576	Lifting Lever Extension
200082D	10881	" " " Screw
227561	16578	" " Spring

## FOOT LIFTER

227952	15352	Foot Lifter Lever (left or right) with 227954
227678	15352	Foot Lifter Lever Chain,48 in. long, with 202784
227954	16581	Foot Lifter Lever Chain Hook (lower)
202784	16578	" " " " " (upper)
225016	16581	" " " Hinge Pin
227953	15352	" " " Stand with two wood screws 1 in.No.12
227955	15352	Foot Lifter Lever (left or right) complete,Nos.225016,227678,227952 and 227953

## THREAD UNWINDER

No.	Plate	Name
225257	14363	Spool Rest (for two spools) with 201018C
150203	-----	Spool Rest Cushion (felt)
225388	14363	" " Rod
200383C	14368	" " " Set Screw
201018C	16578	" " Set Screw
202490	14363	" Stand with 200383C
225391	14363	Thread Guide
201696J	16578	" " Lock Nut
225326	14362	" " Position Cup
225324	14363	" " Rod with 200E and 225322
200E	16578	" " " Screw
225322	14362	" " " Washer
225258	14363	Thread Unwinder (for two spools) com- plete, Nos. 201696J, 202490, 225327, 225324, 225326, 225388 two each 150203 225391 and three wood screws 7/8 in., No. 12

## MISCELLANEOUS PARTS

### USED IN CONJUNCTION WITH THREAD UNWINDER

60913	14363	Spool Weight with 60914
60914	-----	" " Center Pin
225377	14363	" Wire, for small spools
27739	14363	Thread Cone (wood)

## NUMERICAL LIST OF PARTS

NUMERICAL  
LIST  
OF PARTS

No.	Plate	Name
208E	1687E	Thread Unwinder Thread Guide Rod Screw, for 225324
356C	1436C	Knee Lifter Rock Lever Extension Set Screw, for 228295
356C	1436C	Knee Lifter Rock Lever Hinge Pin Set Screw, for 228294
356C	1436C	Knee Lifter Rock Lever Knee Plate Set Screw, for 228294
356C	1436C	Knee Lifter Rock Lever Knee Plate Arm Set Screw
631F	1436C	Thread Plate Screw
210C	10881	Bobbin Winder Tension Disc, for 22549C
12361	14334	Machine Hinge Connection
17739	1436C	Thread Cone (wood)
41400	14334	Machine Rest Pin (wood)
64897	1436C	Red Oil Cup
60913	1436C	Spool Weight with 60914
60914	-----	" " Center Pin, for 60913
12364F	14334	Giler (copper plated) with 12364F
170343	14334	" Spout, 3-1/2 in. long, for 12364F
150203	-----	Thread Unwinder Spool Rest Cushion (felt), for 225258
200004E	1436C	Arm Screw
200006E	13234	Hook Saddle Screw
200009E	13234	" " Pinch Screw, for 223750
200019E	1436C	Feed Driving Rock Shaft Crank Pinch Screw, for 223650
200029E	16577	Lifting Eccentric Connection Crank Pinch Screw, for 240171
200029E	16577	Needle Bar Rock Frame Rock Shaft Crank Pinch Screw, for 223692
200049D	16577	Feed Driving Connection Pinch Screw, for 237565
200054E	16581	Presser Bar Lifting Bracket Pinch Screw, for 264526
200056E	10884	Bobbin Winder Stop Latch Screw, for 225382
200061C	16578	Thread Controller Stud Set Screw
200074F	16218	Lifting Presser Foot Screw, for 208566
200082D	10881	Foot Lifter Lifting Lever Extension Screw
200082D	10881	Bobbin Winder Tension Bracket Screw, for 225382
200086C	16218	Needle Bar Connecting Stud Pinch Screw, for 208552

## NUMERICAL LIST OF PARTS

No.	Plate	Name
200086F	16218	Presser Bar Position Guide Lever Pinch Screw, for 202338
200086C	16218	Presser Bar Spring Bracket Pinch Screw, for 210949
200092D	16218	Safety Clutch Locking Lever Spring Screw, for 265040
200098F	16577	Needle Bar Rock Frame Position Bracket Screw
200106E	14372	Feed Dog Screw
200113F	14327	Arm Shaft Connection Belt Timing Collar Set Screw, for 224113
200113F	14327	Knee Lifter Connection Lever Lifting Rod Spring Collar Set Screw, for 227227
200118D	14372	Bobbin Case Opener Screw, for 240177
200125F	16577	Needle Set Screw, for 264522
200132E	16218	Thread Controller Spring Stop Screw
200157B	16578	Attachment Screw
200159F	16578	Tension Bracket Screw
200160D	14373	Hook Saddle Oil Guard Screw
200161D	16577	Needle Bar Connecting Link Oil Guard Screw
200164B	14327	Arm Shaft Connection Belt Timing Plate Screw
200173D	14368	Feed Lifting Cam Oiling Felt Screw, for 224052
200175D	16577	Needle Bar Thread Guide Screw, for 264522
200256C	14368	Feed Driving Eccentric Regulating Bracket Hinge Screw, for 237043
200256C	14368	Feed Driving Eccentric Regulating Bracket Stop Screw, for 237043
200262H	14373	Knee Lifter Lifting Lever Hinge Screw
200262H	14373	" " Connection Lever Hinge Screw
200278H	14327	Arm Cap Screw
200299H	10884	Bobbin Winder Stop Latch Trip Lever Hinge Screw, for 225382
200309E	16578	Tension Release Lever Screw, for 240446
200327C	14327	Arm Shaft Connection Belt Pulley Set Screw, for 224104
200327C	14327	Hook Driving Shaft Bushing Set Screw
200328C	14327	Balance Wheel Position Screw, for 241561
200335C	14327	" " Set Screw, for 241561
200335C	14327	Needle Bar Crank Set Screw, for 202692
200335C	14327	Hook Saddle Bearing Set Screw
200338C	14327	Arm Shaft Bushing (front) Set Screw
200338C	14327	" " " (back) Set Screw
200347C	13234	Needle Bar Rock Frame Hinge Stud Set Screw
200352C	16580	Presser Bar Position Guide Set Screw

## NUMERICAL LIST OF PARTS

No.	Plate	Name
200352C	16580	Presser Bar Bushing Set Screw
200354C	14373	Hook Driving Shaft Lock Ratchet Position Screw, for 265314
200355H	16578	Thread Retainer Set Screw
200357E	14327	Arm Shaft Oil Packing Stop Screw, for 240102
200362C	13234	Hook Driving Gear Set Screw
200362C	13234	Hook Driving Shaft Lock Ratchet Set Screw, for 223867 and 265314
200363C	16578	Take-up Lever Hinge Stud Set Screw
200364C	14372	Hook Bushing (lower) Set Screw, for 224024 and 240177
200364C	14372	Bobbin Case Opener Lever Hinge Stud Set Screw
200368H	16581	Tension Bracket Screw Socket Set Screw
200374C	13234	Needle Bar Connecting Link Stud Set Screw, for 202692
200380C	10884	Bobbin Winder Pulley Set Screw, for 202473
200382C	14373	Hook Driving Pinion Set Screw
200382C	14373	Lifting Eccentric Set Screw, for 240167 and 240203
200383C	14368	Feed Driving Eccentric Regulating Screw Check Screw
200383C	14368	Feed Driving Eccentric Regulating Bracket Flange Set Screw, for 224108
200383C	14368	Feed Driving Rock Shaft Stop Collar Set Screw, for 202625
200383C	14368	Needle Bar Connecting Link Stud Set Screw, for 202692
200383C	14368	Thread Unwinder Spool Rest Rod Set Screw, for 202490
200387C	16218	Needle Bar Rock Frame Slide Block Screw, Stud Set Screw for 223691
200398C	16580	Lifting Eccentric Position Screw, for 240203
200428C	16577	Needle Bar Crank Position Screw, for 202692
200429C	14368	Feed Driving Eccentric Regulating Screw
200437C	14368	" " " " Bracket Flange Position Screw, for 224108
200446C	14368	Hook Bushing (upper) Position Screw
200473B	14372	Face Plate Thumb Screw
200502B	14327	Arm Shaft Bushing (front) Oil Packing Thumb Screw
200529C	15911	Knee Lifter Rock Lever Rod Set Screw, for 228296
200582H	16578	Thread Guide Screw
200590H	14373	Hook Washer Screw, for 240042
200594C	14372	Bobbin Case Tension Spring Screw, for 233765

## NUMERICAL LIST OF PARTS

No.	Plate	Name
200602E	14327	Arm Shaft Connection Belt Pulley Position Screw, for 224104
200607C	14368	Feed Driving Eccentric Regulating Bracket Plunger Spring Stop Screw
200653C	16577	Presser Bar Lifter Hinge Screw
200833C	16577	Needle Bar Rock Frame Rock Shaft Crank Connection Hinge Screw
200861D	14362	Cloth Guide Thumb Screw
200861D	14362	Bed Slide (back) Locking Thumb Screw
200948F	16577	Presser Bar Spring Support Screw
200962C	16218	Safety Clutch Locking Lever Spring Adjusting Screw, for 265036
200975F	16577	Presser Bar Lifting Bracket Guide Screw
200978H	16218	Thread Controller Disc Screw, for 240446
200984C	14372	Bobbin Case Tension Spring Regulating Screw, for 233765
200993C	16218	Safety Clutch Locking Lever Hinge Screw for 265040
200996C	14373	Lifting Bell Crank Cap Screw
201015F	14362	Vibrating Presser Foot Pinch Screw, for 240150 to 240154 and 240156 to 240158
201018C	16578	Thread Unwinder Spool Rest Set Screw, for 225257
201141C	16580	Needle Bar Rock Frame Slide Block Screw Stud, for 210920
201171C	14372	Feed Driving Connection Hinge Screw
201199F	16578	Thread Controller Stud with 204925, for 240446
201220C	14368	Feed Lifting Cam Set Screw, for 224154
201220C	14368	Hook Driving Pinion Position Screw, for 240167
201222C	13234	Hook Driving Gear Position Screw, for 223867
201224B	16578	Tension Stud, for 240023
201253F	13234	Hook Gib Screw, for 240042
201254C	16218	Safety Clutch Hook Driving Shaft Position Collar Set Screw, for 265032
201349C	14372	Bobbin Case Opener Lever Driving Screw Stud, for 224005
201410F	16581	Presser Bar Spring Regulating Thumb Screw
201499B	10881	Bobbin Winder Tension Stud, for 225461
201517E	16580	Feed Driving Connection Hinge Screw Nut
201518E	14372	Feed Bar Hinge Screw Nut, for 240031
201522E	16218	Needle Bar Rock Frame Rock Shaft Crank Connection Hinge Screw Nut
201524E	16580	Lifting Bell Crank Link Screw Stud Nut, for 240136

## NUMERICAL LIST OF PARTS

No.	Plate	Name
201525E	14368	Feed Driving Eccentric Regulating Bracket Stop Screw Nut, for 237043
201525E	14368	Feed Driving Eccentric Regulating Bracket Hinge Screw Nut, for 237043
201542C	14372	Bobbin Case Opener Lever Driving Screw Stud Nut, for 224005
201572B	10881	Bobbin Winder Tension Stud Thumb Nut, for 225462
201572B	10881	Tension Thumb Nut, for 240446
201572B	10981	Thread Controller Stud Thumb Nut
201696J	16578	" Unwinder Thread Guide Lock Nut, for 225258
202005	14327	Arm Screw Washer
*202056	-----	Bobbin Case Latch Pin, for 233765
202135	14372	Face Plate Position Pin, for 240202
202244	-----	Arm Shaft Bushing (back) Oil Packing (wick), for 240802
202244	-----	Hook Driving Shaft Bushing Oil Packing (wick), for 224111
202244	-----	Arm Shaft Bushing (front) Oil Packing (wick), for 207080
202248	14327	Arm Cap Screw Washer
202253	14327	Safety Clutch Pulley Spring Flange, for 265036
202253	14327	Arm Shaft Connection Belt Pulley Spring Flange, for 224104
202254	-----	Needle Bar Connecting Link Stud Oil Packing (wick), for 202333
202277	-----	Bobbin Case Opener Lever Hinge Stud Oil Packing (wick), for 223622
202277	-----	Bobbin Winder Frame Oil Packing (wick), for 225453
202277	-----	Feed Driving Connection Hinge Screw Oil Packing (wick)
202277	-----	Needle Bar Rock Frame Hinge Stud Oil Packing (wick), for 210910
202277	-----	Needle Bar Rock Frame Rock Shaft Crank Connection Oil Packing (wick), for 223693
202277	-----	Take-up Lever Driving Stud Oil Packing (wick), for 202399
202277	-----	Vibrating Presser Bar Oil Packing (wick)
202301	14368	Feed Driving Eccentric Regulating Bracket Plunger
202302	13234	Knee Lifter Connection Lever Lifting Rod Cotter Pin, for 223684
*202311	-----	Feed Regulating Spindle Head, for 224122
202330	-----	Needle Bar Connecting Stud Oil Packing (wick), for 208552

## NUMERICAL LIST OF PARTS

No.	Plate	Name
202330	-----	Feed Driving Connection Oil Packing (wick), for 237565
202333	16577	Needle Bar Connecting Link Stud with 202254, for 202692
202337	16577	Presser Bar Position Guide
202338	16577	" " " " Lever with 200086F
202399	16577	Take-up Lever Driving Stud with 202277, for 240178
202400	16577	Take-up Lever Hinge Stud with 202423, for 240178
202407	10881	Bobbin Winder Tension Spring, for 225460
202417	16578	Thread Guide
202423	-----	Take-up Lever Hinge Stud Oil Packing (wick), for 202400
202443	14368	Feed Regulating Spindle Head Pin, for 224122
202455	15911	Knee Lifter Rock Lever Knee Plate Arm, for 228098
202473	10885	Bobbin Winder Pulley with 200380C, for 225382
202478	10884	Bobbin Winder Stop Latch Trip Lever, for 225832
202490	14363	Thread Unwinder Spool Stand with 200383C, for 225258
202552	13234	Needle Bar Connecting Link, for 240178
202619	14368	Feed Regulating Spindle Head Position Pin, for 224122
202625	14368	Feed Driving Rock Shaft Stop Collar with two 200583C
202666	16577	Needle Bar Rock Frame Position Bracket
202668	16577	" " " " Slide Block, for 210920
202692	16576	Needle Bar Crank with 200335C, 200374C, 200383C, 200408C and 202333, for 240178
202784	16578	Foot Lifter Lever Chain Hook (upper), for 227678
203101	-----	Bobbin Case Opener Lever Driving Screw Stud Oil Packing (wick), for 224005
203172	16577	Needle Bar Crank Friction Washer
203214	14372	Bobbin Case Tension Spring, for 233765
203216	-----	" " Washer (cloth), for 233765
203470	14372	Bobbin
203473	14372	" Case Latch Plunger, for 233765
203474	14372	" " " Spring, for 233765
203525	14373	Hook Gib, for 240042
203648	14372	Bobbin Case Latch, for 233765
204235	14327	Arm Position Pin

## NUMERICAL LIST OF PARTS

No.	Plate	Name
204264	14362	Vibrating Presser Bar Extension Collar Pin, for 240185
204271	16578	Tension Release Washer, for 240446
204925	16578	Thread Controller Stud Washer, for 201199F
206628	14373	Knee Lifter Connection Lever Lifting Rod Spring
207072	16577	Presser Bar Bushing (upper)
207080	14364	Arm Shaft Bushing (front) with 202244
208490	16579	Knee Lifter Connection Lever
208552	16580	Needle Bar Connecting Stud with 200086C and 202330, for 240178
208566	16579	Presser Bar with 200074F
210910	13234	Needle Bar Rock Frame Hinge Stud with 202277
210920	-----	Needle Bar Rock Frame Slide Block 202668 with 201141C, for 223691
210933	-----	Lifting Eccentric Connection Crank Oil Packing (wick), for 240171
210949	16218	Presser Bar Spring Bracket with 200086C
210955	16578	Thread Guide (upper)
214838	14362	" Lubricator Screw Washer, for 237846
223438	16578	Tension Spring, for 240446
223622	14372	Bobbin Case Opener Lever Hinge Stud with 202277 and 240177
223623	14372	Bobbin Case Opener Lever Link, for 240177
223650	14348	Feed Driving Rock Shaft, for 240031
223652	14368	" " " " Crank with 200019E
223655	-----	" Lifting Cam Oiling Felt, for 224052
223681	16576	Hook Saddle Bearing
223684	14365	Knee Lifter Connection Lever Lifting Rod with 202302
223690	-----	Needle Bar Rock Frame Rock Shaft, for 223691
223691	14348	Needle Bar Rock Frame Rock Shaft 223690 with 200387C and 210920
223692	16576	Needle Bar Rock Frame Rock Shaft Crank with 200029E
223693	16576	Needle Bar Rock Frame Rock Shaft Crank Connection with 202277
223703	16578	Tension Release Lever, for 240446
223704	16578	" " Plunger, for 240446
223706	16578	Thread Controller Disc, for 240446
223733	16576	Foot Lifter Lifting Lever Extension
223811	14372	Bed Slide (back) Stop
223812	14372	" " " " Spring
223850	-----	Hook Saddle with 200009E, for 224024
223867	13234	" Driving Gear (spiral) with 200362C and 201222C

## NUMERICAL LIST OF PARTS

No.	Plate	Name
224004	14372	Bobbin Case Opener, for 240177
224005	14372	" " " Lever with 201349C, 201542C and 203101, for 240177
224019	14368	Hook Bushing (lower) (bronze), for 224024
224020	14368	Hook Bushing (upper) (bronze), for 224024
224022	14373	Hook Driving Pinion Thrust Washer, for 240177
224024	16576	Hook Saddle 223850 with 200364C, 224019 and 224020, for 240177
224025	14373	Hook Washer, for 240042
224040	16578	Thread Guide
224052	14368	Feed Lifting Cam Fork with 200173D and 223655, for 240038
224103	14348	Arm Shaft Connection Belt
224104	14364	" " " " Pulley with 200327C, 200602E and two 202253
224108	14364	Feed Driving Eccentric Regulating Bracket Flange with 200333C and 200437C, for 237043
224111	14364	Hook Driving Shaft Bushing (back) with 202244
224113	14327	Arm Shaft Connection Belt Timing Collar with 200113F
224121	-----	Drip Pan, 20 in. long, with four 1 in. wire nails
224122	14364	Feed Regulating Spindle with 202311, 202443 and 202619
224139	14327	Arm Shaft Connection Belt Timing Plate
224154	14368	Feed Lifting Cam with 201220C
224392	-----	Arm Shaft Oil Packing (wick), for 240102
225016	16581	Foot Lifter Lever Hinge Pin, for 227955
225257	14363	Thread Unwinder Spool Rest (for two spools) with 201018C, for 225258
225258	14363	Thread Unwinder (for two spools) complete, Nos. 201696J, 202490, 225257, 225324, 225326, 225388 two each 150203 225391 and three wood screws 7/8 in., No. 12
225322	14362	Thread Unwinder Thread Guide Rod Washer for 225324
225324	14363	Thread Unwinder Thread Guide Rod with 208E and 225322, for 225258
225326	14362	Thread Unwinder Thread Guide Position Cup, for 225258
225377	14363	Spool Wire, for small spools
225381	10884	Bobbin Winder Spindle, for 225382

## NUMERICAL LIST OF PARTS

No.	Plate	Name
225382	10885	Universal Bobbin Winder complete, Nos. 200056E, 200082D, 200299H, 202473, 202478, 225361, 225433, 225444, 225453 to 225456, 225458, 225462, 228026 two each 225459 and wood screws 3/4 in., No. 12, R. H. B.
225388	14363	Thread Unwinder Spool Rest Rod, for 225258
225391	14363	Thread Unwinder Thread Guide, for 225258
225433	10885	Bobbin Winder and Tension Bracket Base, for 225382
225438	10884	Bobbin Winder Frame Oil Well Cap, for 225433
225444	10884	Bobbin Winder Stop Latch, for 225382 Nos. 225453 to 225456, for 225382
225453	10884	Bobbin Winder Frame with 200277 and 225438
225454	10884	Bobbin Winder Frame Hinge Pin
225455	10884	" " " Spring
225456	10884	" " " Plunger
225458	10884	" " Stop Latch Thumb Lever, for 225382
225459	10884	Bobbin Winder Stop Latch Thumb Lever Hinge Stud, for 225382
225459	10884	Bobbin Winder Stop Latch Thumb Lever Joint Stud, for 225382
225461	10881	Bobbin Winder Tension Bracket with 201499B, for 225462
225462	10881	Bobbin Winder Tension Bracket complete, Nos. 201572B, 202407, 225461 and two 2102, for 225382
*225482	-----	Bobbin Case Screw Driver Blade, for 225497
*225483	-----	Bobbin Case Screw Driver Handle, for 225497
*225484	-----	Screw Driver Blade, for 225498
*225485	-----	" " Handle, for 225498
225497	14334	Bobbin Case Screw Driver complete, Nos. 225482 and 225483
225498	14334	Screw Driver complete, (7-1/4 in. long), Nos. 225484 and 225485
225554	14334	Wrench (steel)
225585	13234	Hook Saddle Screw Washer
225837	14368	Feed Lifting Cam Fork Screw Washer, for 240036
227227	14373	Knee Lifter Connection Lever Lifting Rod Spring Collar with 200113F
227561	16578	Foot Lifter Lifting Lever Spring
227678	15352	" " Lever Chain, 48 in. long, with 202784, for 227955

From the library of: Hiram D. Needle Co.

## NUMERICAL LIST OF PARTS

No.	Plate	Name
227728	15911	Knee Lifter Rock Lever Rod with 227729, for 228298
*227729	-----	Knee Lifter Rock Lever Rod Cap, for 227728
227952	15352	Foot Lifter Lever (left or right) with 227954, for 227955
227953	15352	Foot Lifter Lever Stand with two wood screws 1 in. No. 12, for 227955
227954	16581	Foot Lifter Lever Chain Hook (lower), for 227952
227955	15352	Foot Lifter Lever (left or right) complete, Nos. 225010, 227678, 227952 and 227953
228026	10884	Bobbin Winder Tension Bracket Screw Washer, for 228299
228284	15911	Knee Lifter Rock Lever Knee Plate with 356C, for 228298
228294	15911	Knee Lifter Rock Lever with two 356C, for 228299
228295	15911	Knee Lifter Rock Lever Bracket with 356C and four wood screws 7/8 in., No. 12, for 228299
228296	15911	Knee Lifter Rock Lever Extension with 200529C, for 228298
228297	15911	Knee Lifter Rock Lever Hinge Pin, for 228299
228298	15911	Knee Lifter complete, Nos. 202455, 227728, 228284, 228296 and 228299
228299	-----	Knee Lifter Rock Lever Bracket 228295 with 228294 and 228297, for 228298
231337	14362	Cloth Guide
*233764	-----	Bobbin Case, for 233765
233765	14372	Bobbin Case complete, Nos. 200894C, 200984C, 202056, 203214, 203216, 203473, 203474, 203648, 233764, 241674, 241675 and two 350405C, for 240207
234047	16581	Tension Bracket Screw Socket
235576	16581	" Release Lever Rod
236060	16578	" Disc Position Pin, for 240023
237043	-----	Feed Driving Eccentric Regulating Bracket 237521 with 224108, two each 200256C and 201525E
237174	16578	Thread Controller Spring, for 240446
237521	14364	Feed Driving Eccentric Regulating Bracket, for 237043
237523	14368	Feed Driving Eccentric Regulating Bracket Plunger Spring
237529	16576	Hook Driving Shaft Bushing (front)
237565	14365	Feed Driving Connection with 200049D and 202330

## NUMERICAL LIST OF PARTS

No.	Plate	Name
237836	14365	Presser Bar Spring (flat)
237845	14362	Thread Lubricator Oil Pad Holder, for 237846
237846	-----	Thread Lubricator complete, Nos. 214838, 237845, 240439, 241755, 241758, 241759 and 350280F
240003	14364	Bed Slide (back)
240004	14364	" " (front)
240018	16576	Hook Saddle Oil Guard
240019	-----	" " " " Felt
240023	14375	Tension Bracket with 201224B and 236060 for 240446
240031	-----	Feed Driving Rock Shaft 202360 with 201818E, 240031 and 350393C
240034	16581	Thread Retainer
240037	14364	Feed Bar, for 240038
240038	-----	Feed Bar 240037 with 224052, 222837 and 350197E, for 240031
*240041	-----	Hook (sewing), for 240042
240042	14373	" 240041 with 203526, 224025, two each 200590H and 201253F, for 240207
240069	14364	Arm Cap with 244071
240102	14365	" Shaft with 200357E and 224390
*240103	-----	Bed
240105	14344	Feed Dog, 46 needle hole, for needle sizes 16 and 18, for 240143
		Nos. 240106 to 240108, for 240144
240106	14344	Feed Dog, 40 needle hole, for needle sizes 20 and 22
240107	14344	Feed Dog, 46 needle hole, for needle sizes 16 and 18
240108	14344	Feed Dog, 50 needle hole, for needle sizes 14 and 15
		Nos. 240109 to 240111, for 240145
240109	14351	Feed Dog, 50 needle hole, for needle sizes 14 and 15
240110	14351	Feed Dog, 46 needle hole, for needle sizes 16 and 18
240111	14351	Feed Dog, 40 needle hole, for needle sizes 20 and 22
240112	16580	Feed Dog, 40 needle hole, for needle sizes 20 and 22, for 240144
240124	16579	Knee Lifter Lifting Lever
240125	16580	Lifting Bell Crank Link
240126	16579	" Eccentric Connection
240128	14344	" Presser Foot, for closing gloves, for 240150 to 240152
240130	14351	Lifting Presser Foot, for cording and general upholstery, for 240154
240132	14351	Lifting Presser Foot, for 240156

From the Library of: Diamond Needle Corp



## NUMERICAL LIST OF PARTS

No.	Plate	Name
240133	14344	Lifting Presser Foot, for 240133
240134	14351	" " " " 240157
240135	16580	" " " " cording and general upholstery
240136	16579	Lifting Rock Shaft with 2015F4E and 350172C
240142	16581	Tension Release Slide Spring
240143	14344	Throat Plate, for 240105
240144	14344	" " " " 240106 to 240108, 240112 and 264509
240145	14351	Throat Plate, for 240109 to 240111 Nos. 240150 to 240152, for 240128
240150	14344	Vibrating Presser Foot, 38 needle hole, with 201015F, for closing gloves
240151	14344	Vibrating Presser Foot, 50 needle hole, with 201015F
240152	14344	Vibrating Presser Foot, 46 needle hole, with 201015F
240153	14344	Vibrating Presser Foot, 40 needle hole, with 201015F and 240133
240154	14351	Vibrating Presser Foot, 40 needle hole, with 201015F, for 240130
240156	14351	Vibrating Presser Foot, 46 needle hole, with 201015F, for 240132
240157	14351	Vibrating Presser Foot, 40 needle hole, with 201015F, for 240134
240158	16580	Vibrating Presser Foot, 40 needle hole, with 201015F
240167	14373	Hook Driving Pinion (spiral) with 200382C and 201220C, for 240177
240170	16580	Needle Bar Thread Guide, for 264522
240171	16580	Lifting Eccentric Connection Crank with 200029E and 210933
240174	16580	Lifting Rock Shaft Bushing
240177	-----	Hook Saddle complete, Nos. 200118D, 200364C, 223622, 223623, 224004, 224005 224022, 224024, 240167 and 240207
240178	-----	Needle Bar Crank 202692 with 202399, 202400, 202552, 208552 and 241518
240179	14365	Face Plate
240183	14362	Vibrating Presser Bar
240184	14362	" " " " Connecting Link
240185	14362	" " " " Extension with 204264 and 240186
240186	14362	Vibrating Presser Bar Extension Collar for 240185
240188	14362	Vibrating Presser Bar Spring
*240202	-----	Arm with 202135
240203	16579	Lifting Eccentric with 200382C and 200398C

## NUMERICAL LIST OF PARTS

No.	Plate	Name
240205	16580	Lifting Bell Crank
240207	-----	Hook and Bobbin Case complete, Nos. 233765 and 240042, for 240177
240213	14373	Hook Driving Shaft Lock Stud, for 240215
240214	14373	" " " " " Socket, for 240215
240215	-----	Hook Driving Shaft Lock Stud complete, Nos. 240213, 240214, 246423 and 246425
240216	14365	Hook Driving Shaft
240439	14362	Thread Lubricator Oil Pad Retainer, for 237846
240446	-----	Tension Bracket complete, Nos. 200979H, 201199F, 204271, 223438, 223703, 223704 223706, 2237174, 240023 two each 200309E, 201572B and 241048
240807	14364	Arm Shaft Bushing (back) with 202244
241352	16581	Presser Bar Bushing (lower)
241518	14375	Take-up Lever, for 240178
241561	14365	Balance Wheel (disc) (belt groove 2-3/4 in. diam.) with 200328C and 200335C
241674	-----	Bobbin Case Oiling Felt, for 233765
241675	14372	" " " " Retainer, for 233765
241755	-----	Thread Lubricator Oil Pad (felt), for 237846
241758	14362	Thread Lubricator Oil Reservoir, for 237846
241759	-----	Thread Lubricator Oil Wick for 237846
242117	16581	" Controller Spring Stop
244048	13234	Tension Disc, for 240446
244071	-----	Arm Cap Oil Wick, for 240038
248423	14373	Hook Driving Shaft Lock Stud Cotter Pin for 240215
248425	14373	Hook Driving Shaft Lock Stud Spring, for 240215
264509	16580	Feed Dog, 40 elongated needle hole, for needle sizes 23 and 24, for 240144
264522	16579	Needle Bar with 200125F, 200175D and 240170
264523	16579	Needle Bar Rock Frame
246525	16579	Presser Bar Lifter
264526	16581	" " Lifting Bracket with 200054E
264527	16581	Tension Release Slide
264718	16580	Needle Bar Connecting Link Oil Guard
265032	16218	Safety Clutch Hook Driving Shaft Posi- tion Collar with two 201254C, for 265040
265035	16218	Safety Clutch Locking Lever Spring, for 265040

For the Library of Parliament

## NUMERICAL LIST OF PARTS

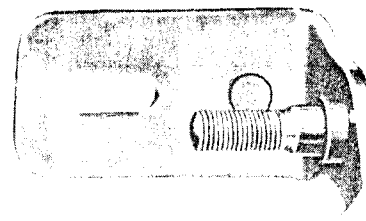
No.	Plate	Name
265036	16576	Safety Clutch Pulley with 200962C and 202253, for 265040
265040	-----	Safety Clutch complete, Nos. 200097D, 200993C, 265032, 265035, 265036, 265050 to 265052, 265056 and 265057 Nos. 265050 to 265052, for 265040
265050	16218	Safety Clutch Locking Lever Connecting Link
265051	16218	Safety Clutch Throw-In Latch Spring
265052	16218	" " " " Pin
265056	16218	" " Locking Lever, for 265040
265057	16218	" " Throw-in Latch, for 265040
265314	16576	Hook Driving Shaft Lock Ratchet with 200354C and 200367C
350172C	16580	Lifting Bell Crank Link Screw Stud, for 240136
350197E	14368	Feed Lifting Cam Fork Screw, for 240038
350280F	14362	Thread Lubricator Screw, for 237846
350299C	14362	Vibrating Presser Bar Thumb Screw (pressure regulating)
350393C	14372	Feed Bar Hinge Screw (driving), for 240031
350405C	14372	Bobbin Case Cilling Felt Retainer Screw, 233765

**Genuine Singer Needles should be used  
in Singer Machines.  
These Needles and their Containers  
are marked with the  
Company's Trade Mark "SIMANCO." 1**

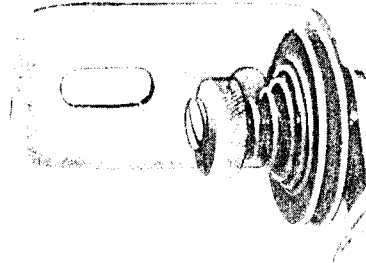
**Needles in Containers marked  
"For Singer Machines"  
are not Singer made needles. 2**

20052

20053 20054



20055



From the library of **Diamond Need Corp.**

ILLUSTRATIONS  
OF  
PARTS

PLATE 10884 FULL SIZE

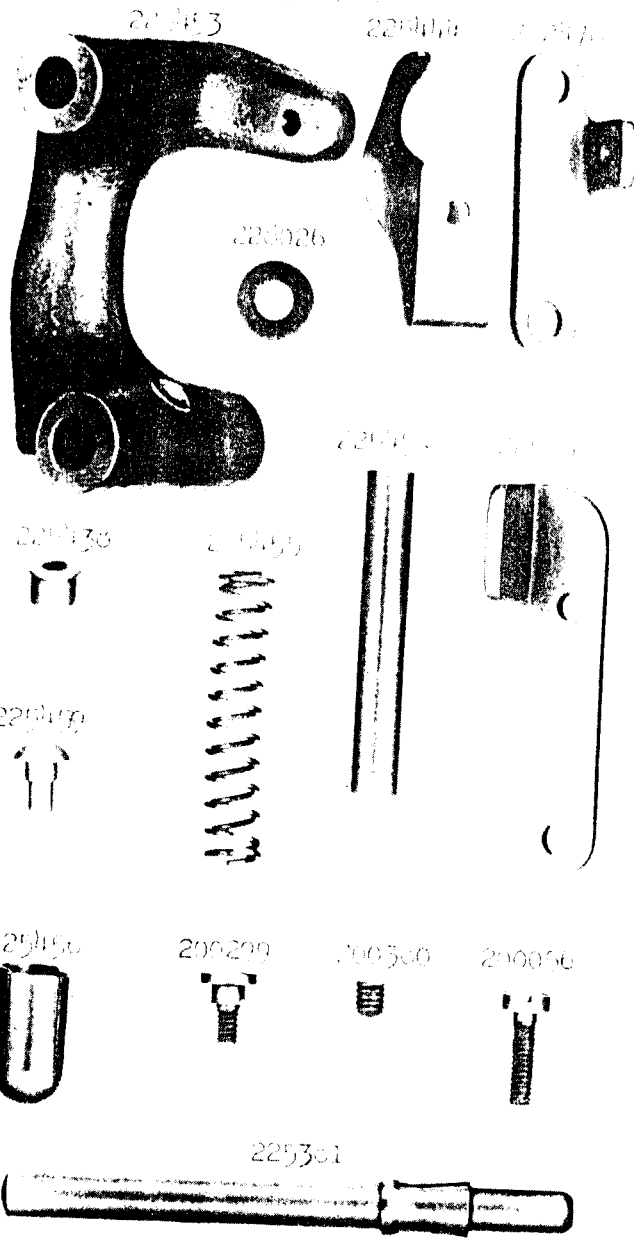
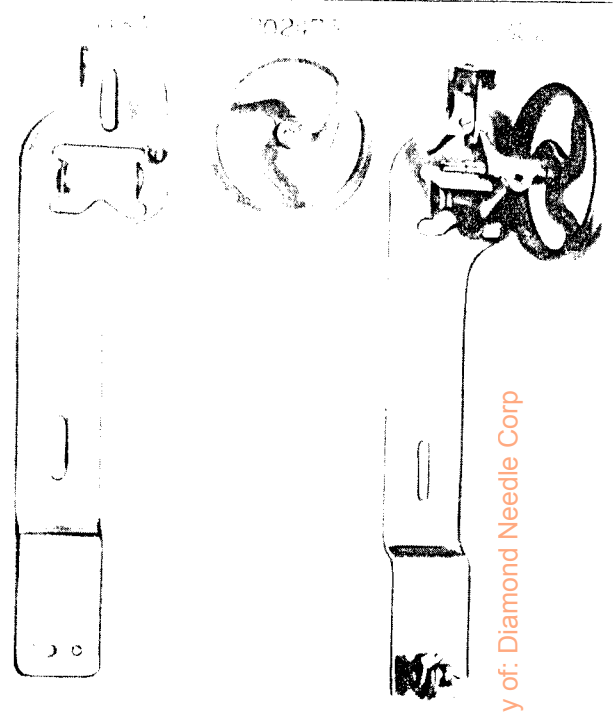


PLATE 10885 ONE-FOURTH SIZE



From the library of: Diamond Needle Corp

PLATE I3234 - FULL SIZE

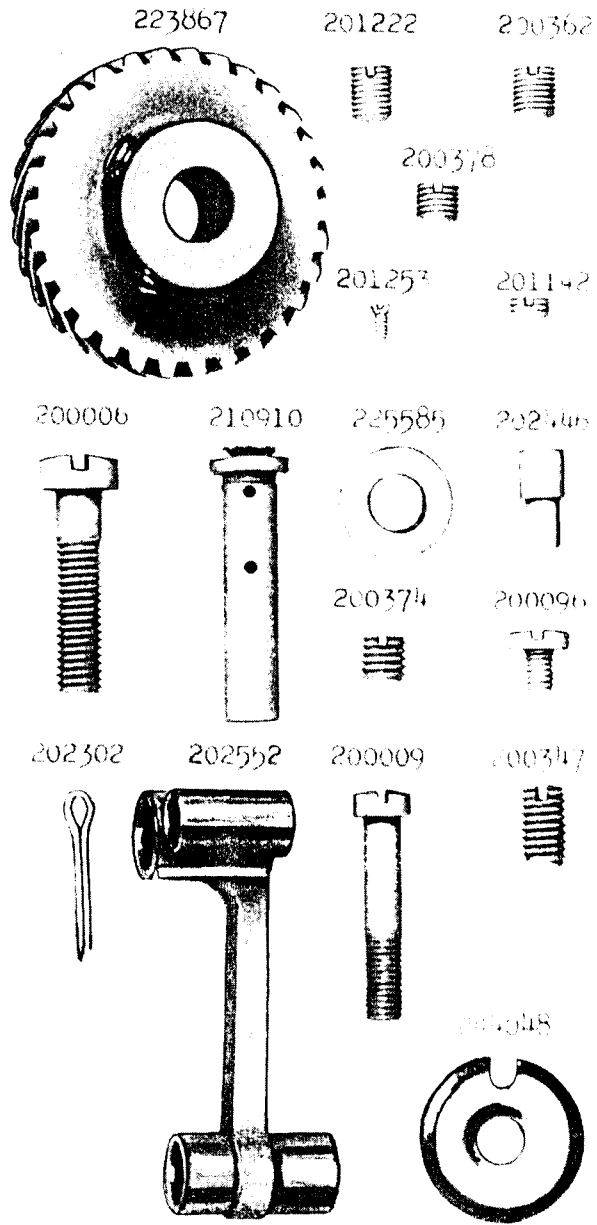


PLATE I4327 - FULL SIZE

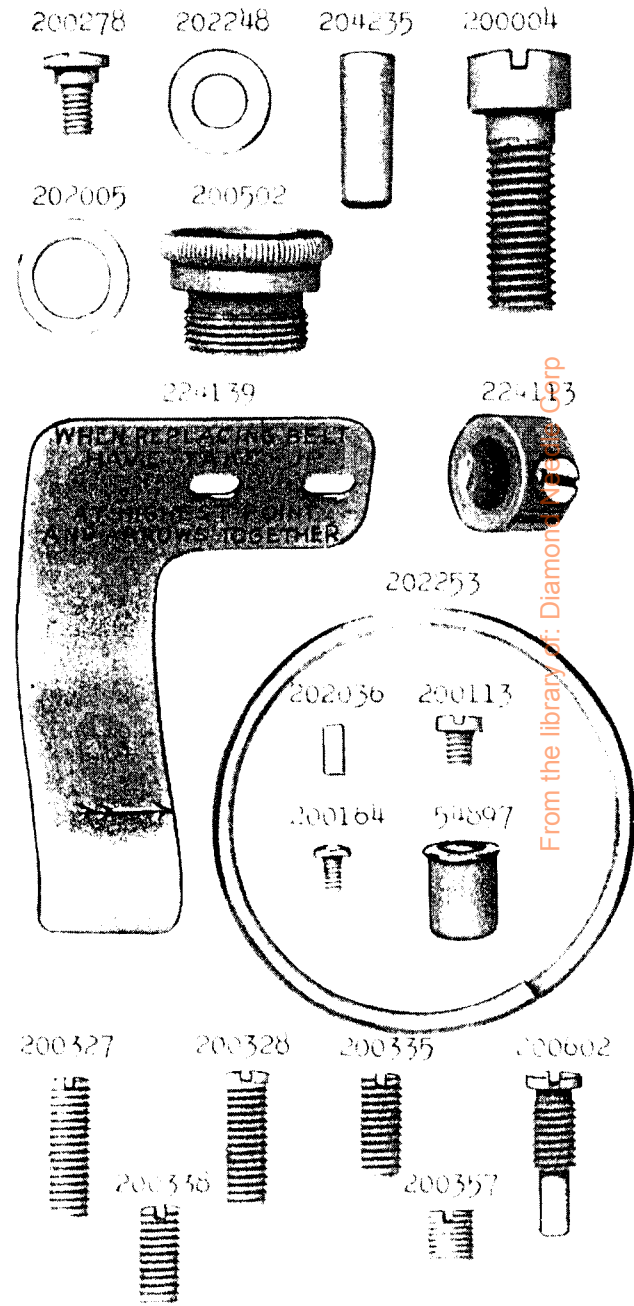


PLATE 14334 - ONE-HALF SIZE

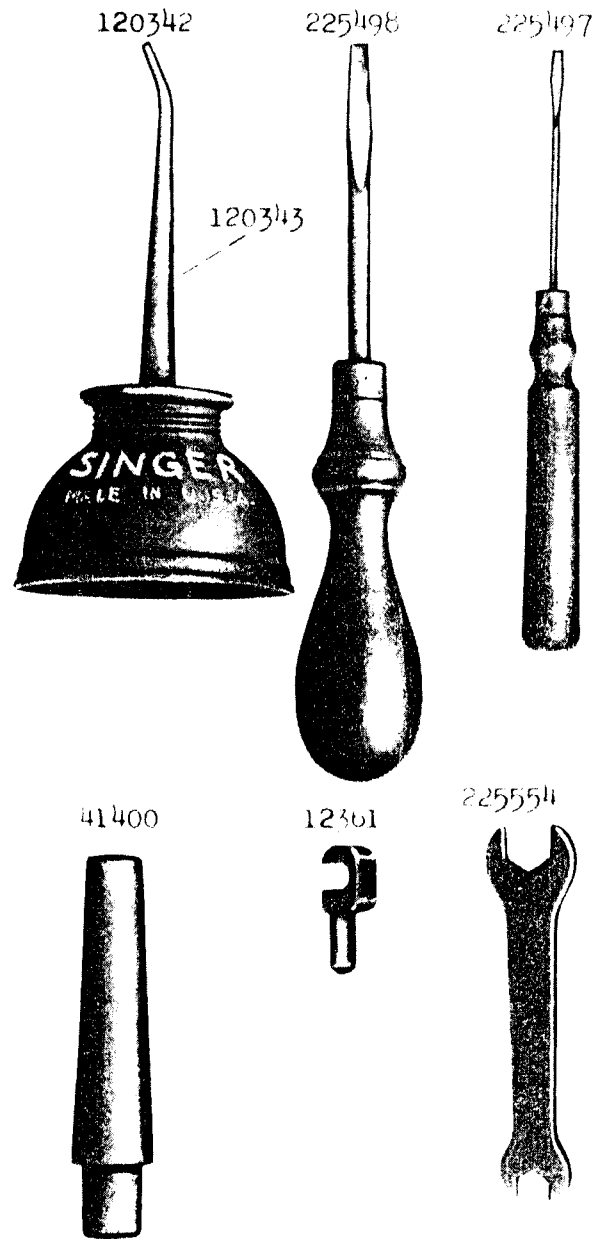
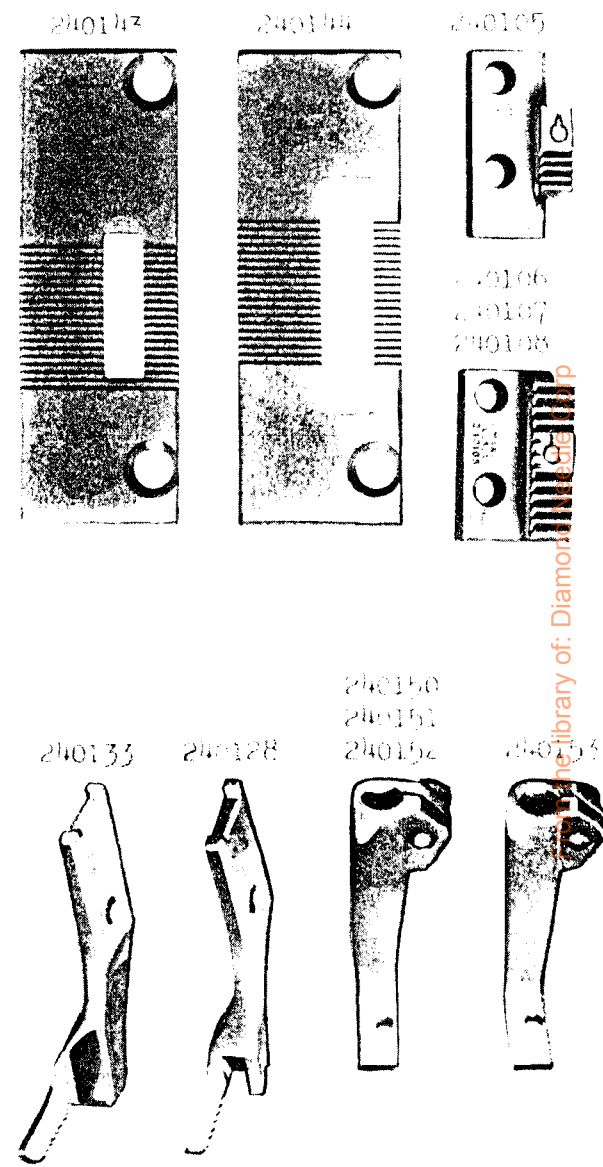


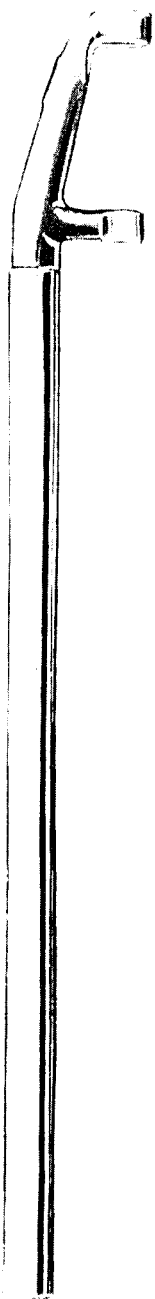
PLATE 14344 - FULL SIZE



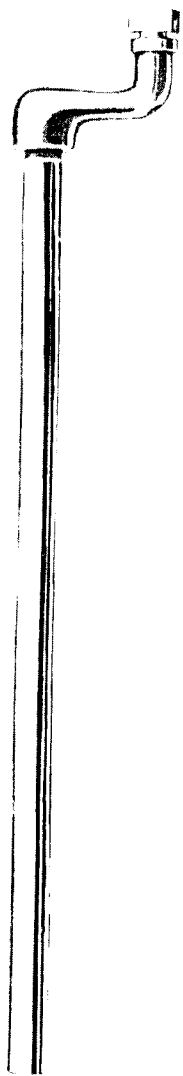
The library of: Diamond

PLATE 14348 - ONE-HALF SIZE

223650



223691



224103

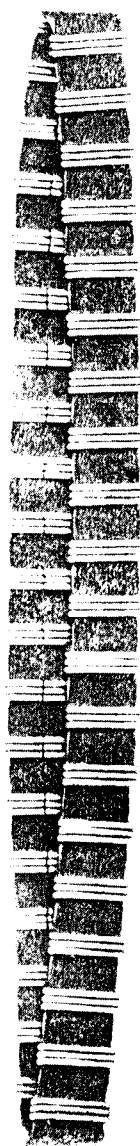


PLATE 14351 - FULL SIZE

240130



240132



240133



240134



240154



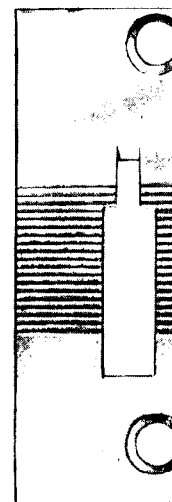
240156



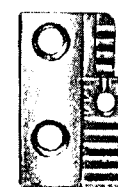
240157



240145



240109  
240110  
240111



From the library of: Diamond Needle Corp

PLATE 14362 - FULL SIZE

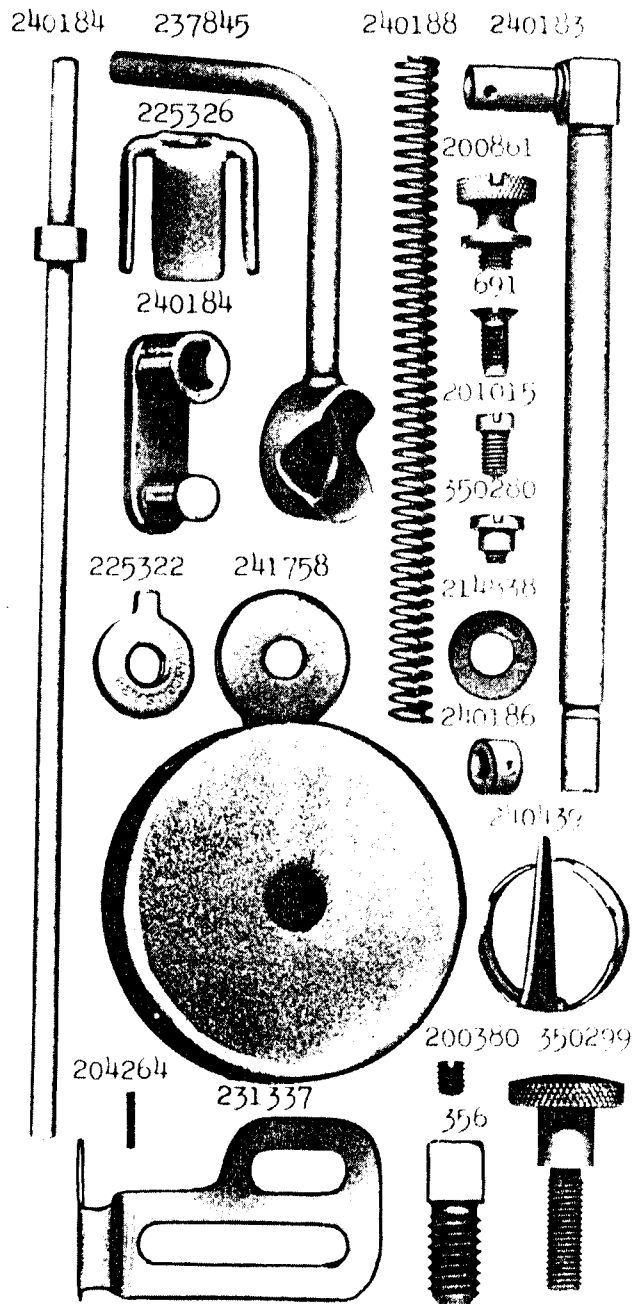
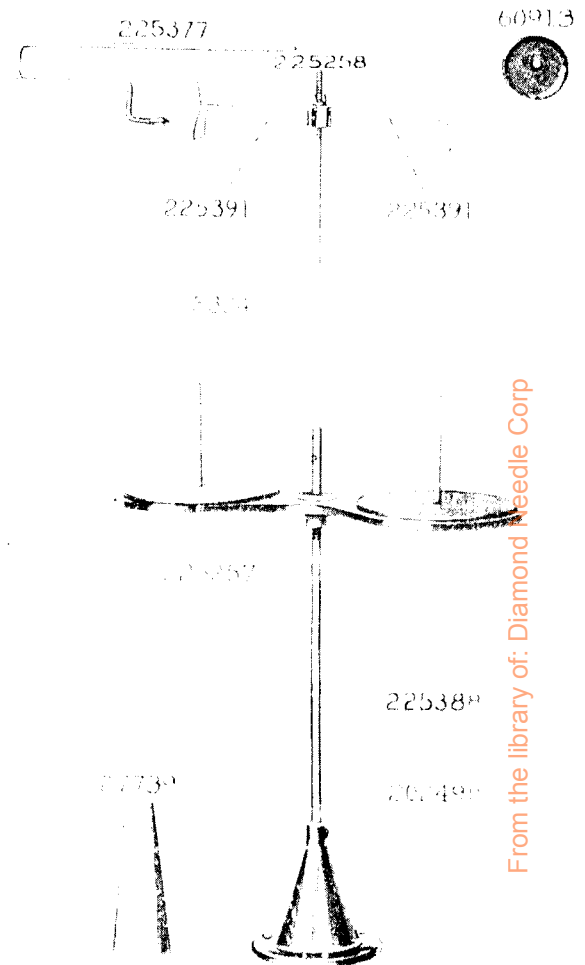


PLATE 14363—ONE-SIXTH SIZE



From the library of: Diamond Needle Corp



PLATE 14364 - ONE-HALF SIZE

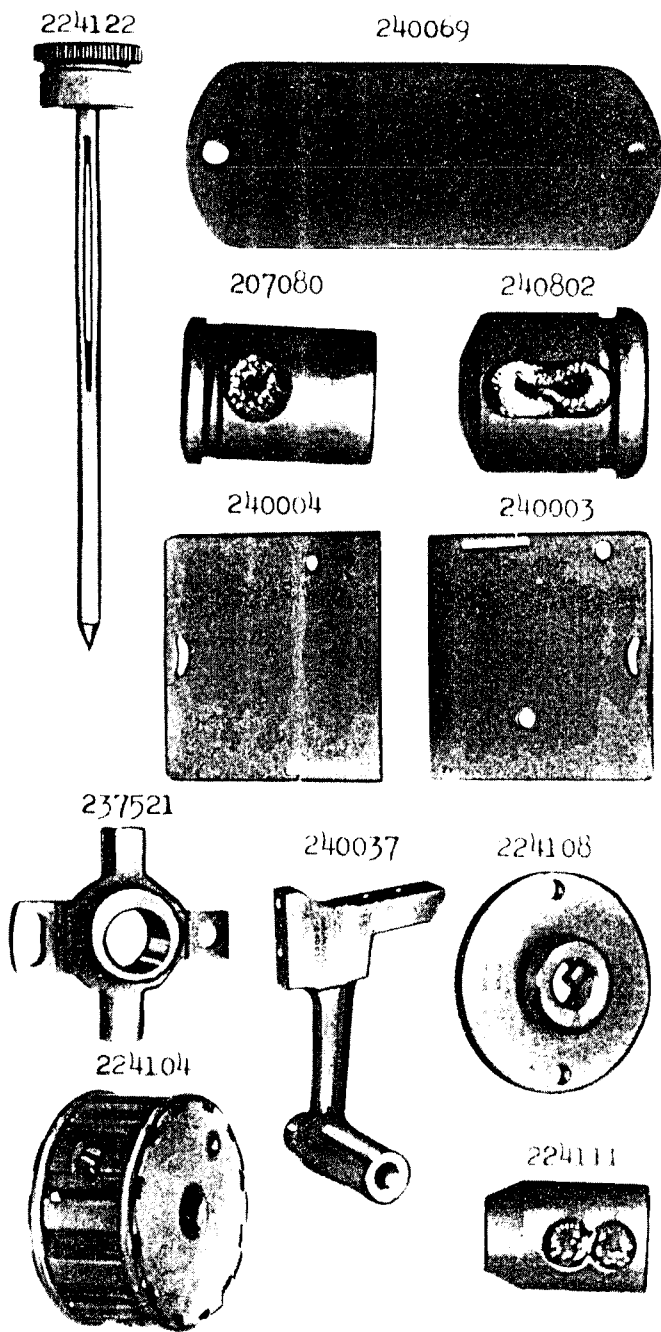
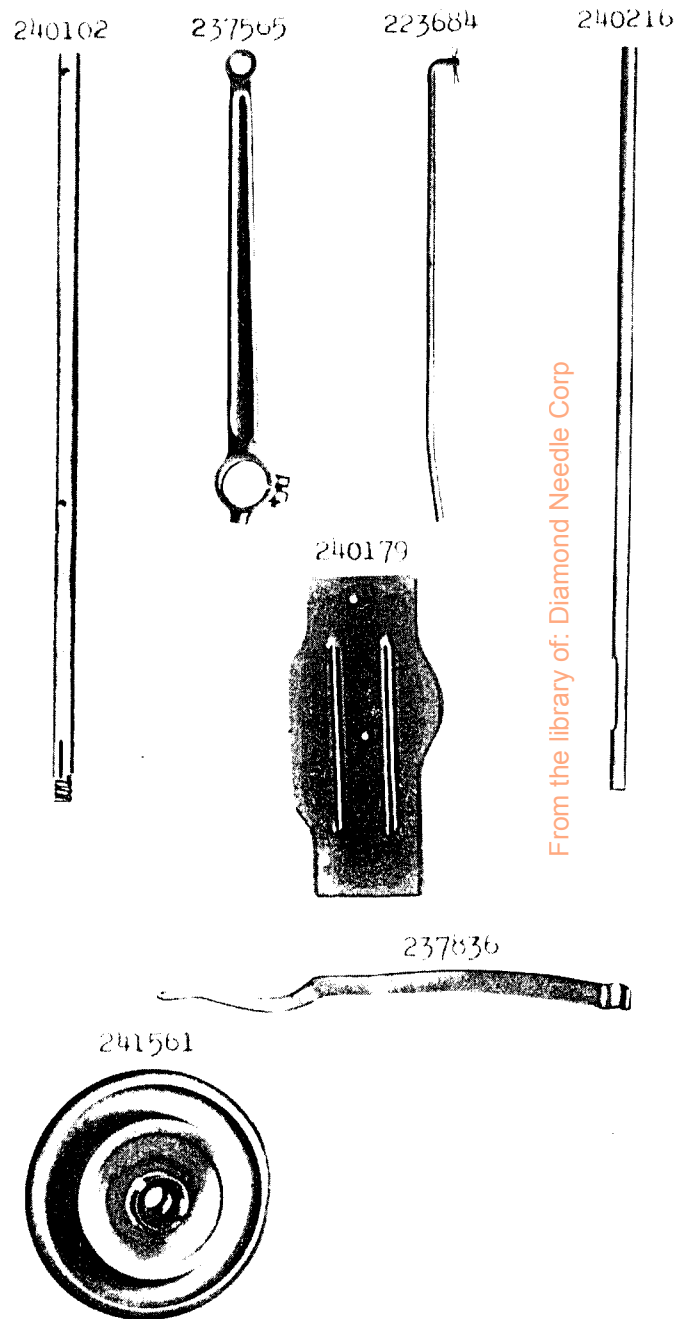


PLATE 14365 - ONE-FOURTH SIZE



From the library of: Diamond Needle Corp

PLATE 14368 - FULL SIZE

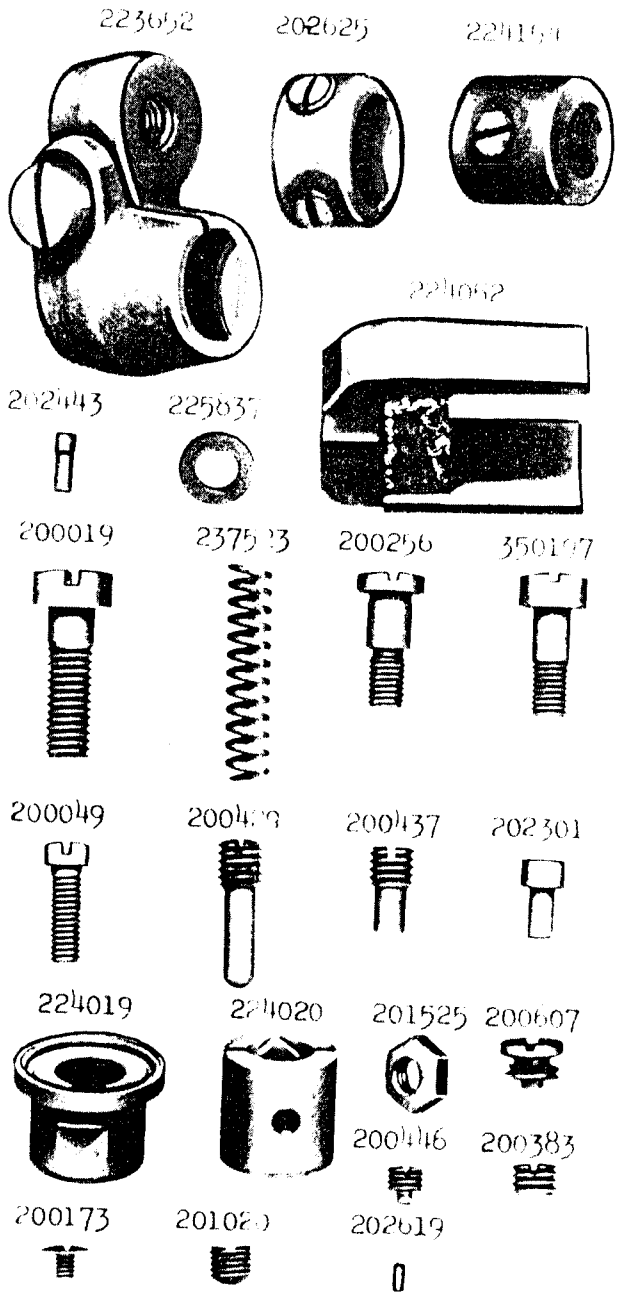
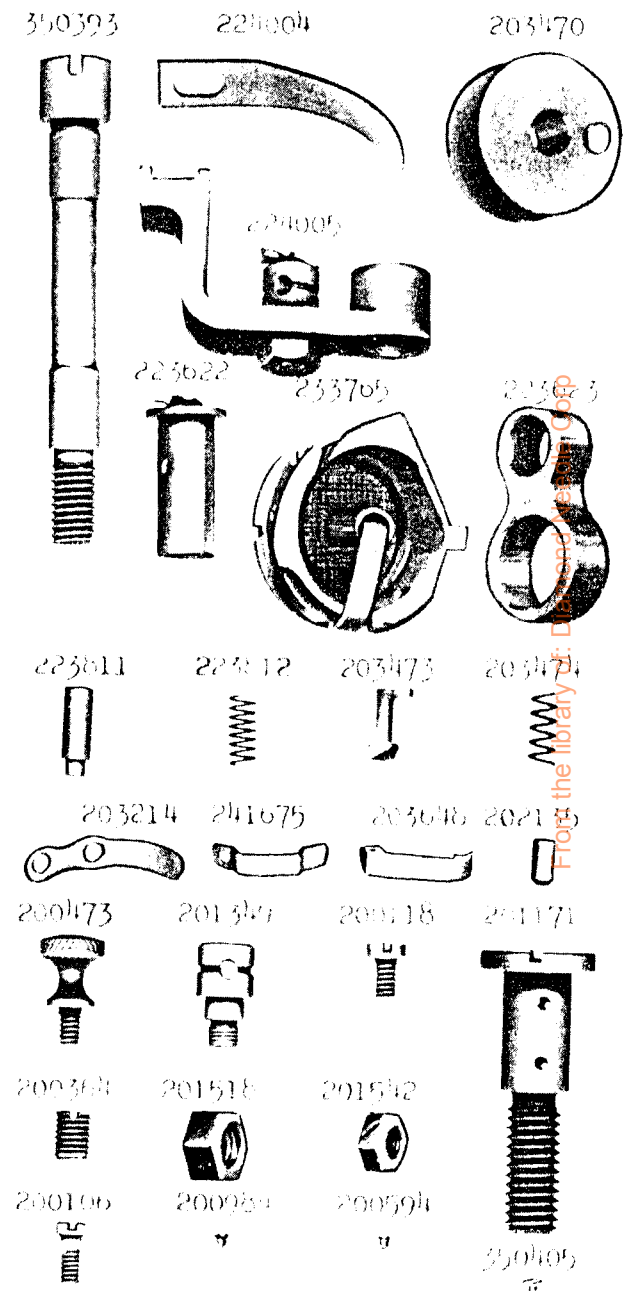


PLATE 14372 - FULL SIZE



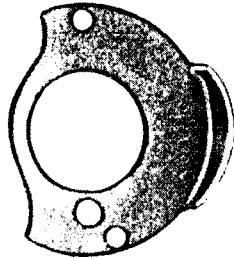
From the library of: Digitized by:

PLATE 14373 - FULL SIZE

206628



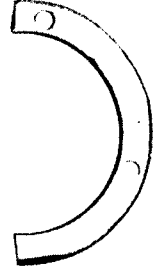
224025



224022



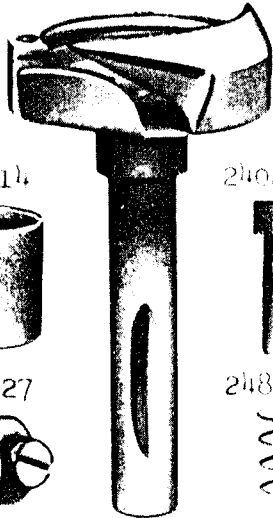
203525



240167



240042



200262



240214



240213



200354



227227



248125



200382



248423



200996



200590

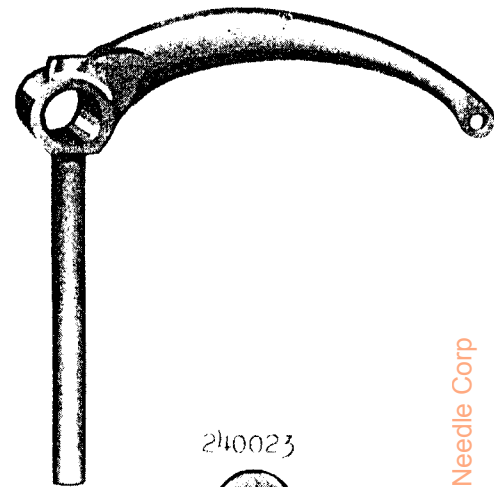


200160

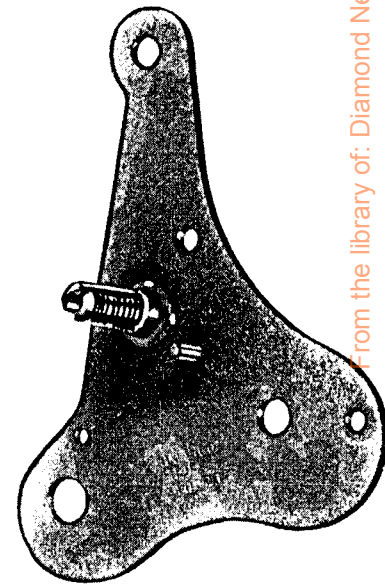


PLATE 14375 - FULL SIZE

241518

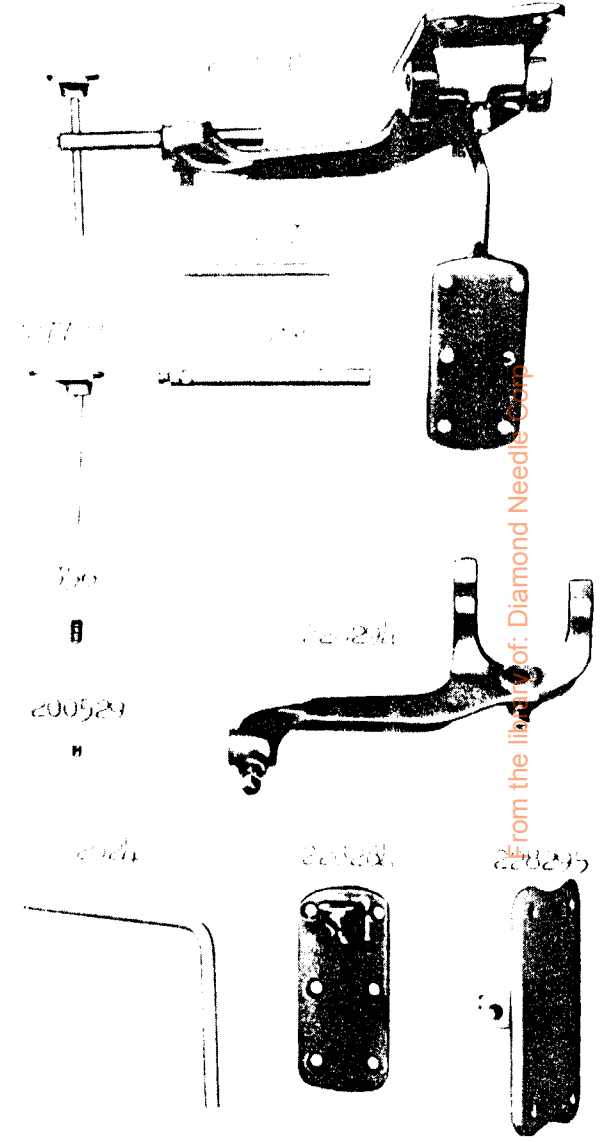
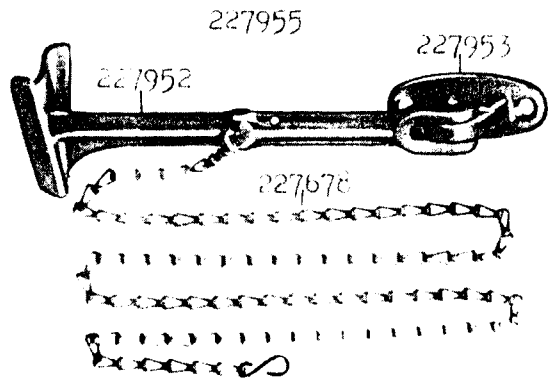


240023



From the library of: Diamond Needle Corp

PLATE 15352 - ONE-FOURTH SIZE



From the library of: Diamond Needle Corp

PLATE 16218 - FULL SIZE

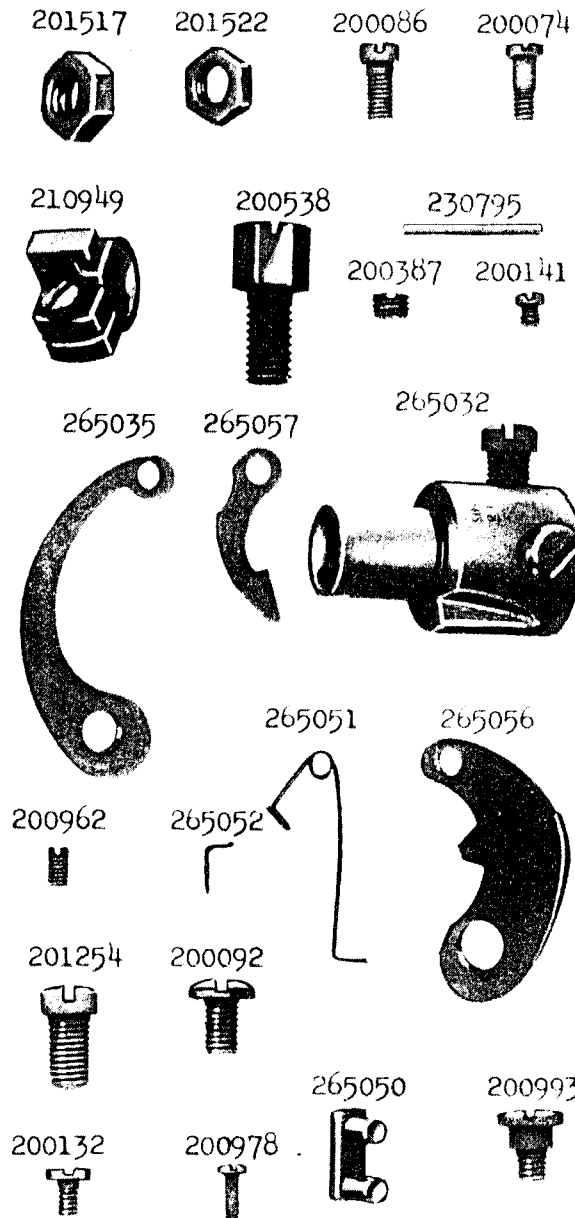


PLATE 16576 - ONE-HALF SIZE

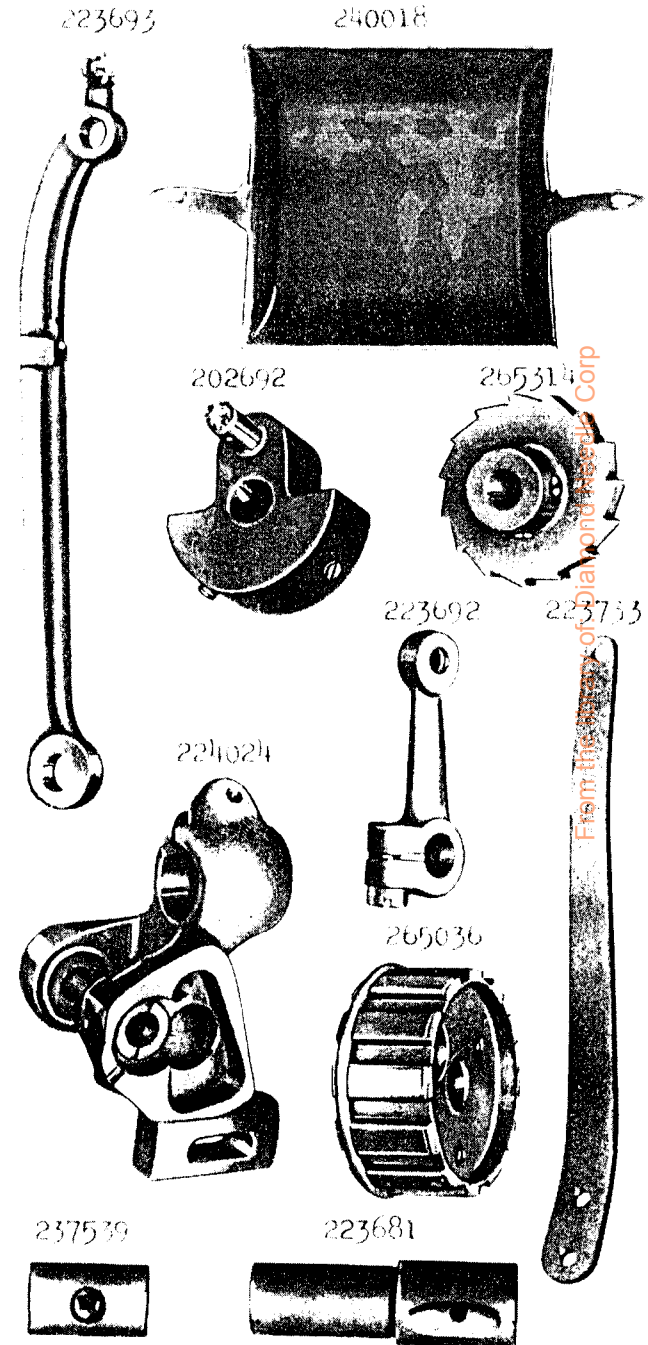


PLATE 16577 - FULL SIZE

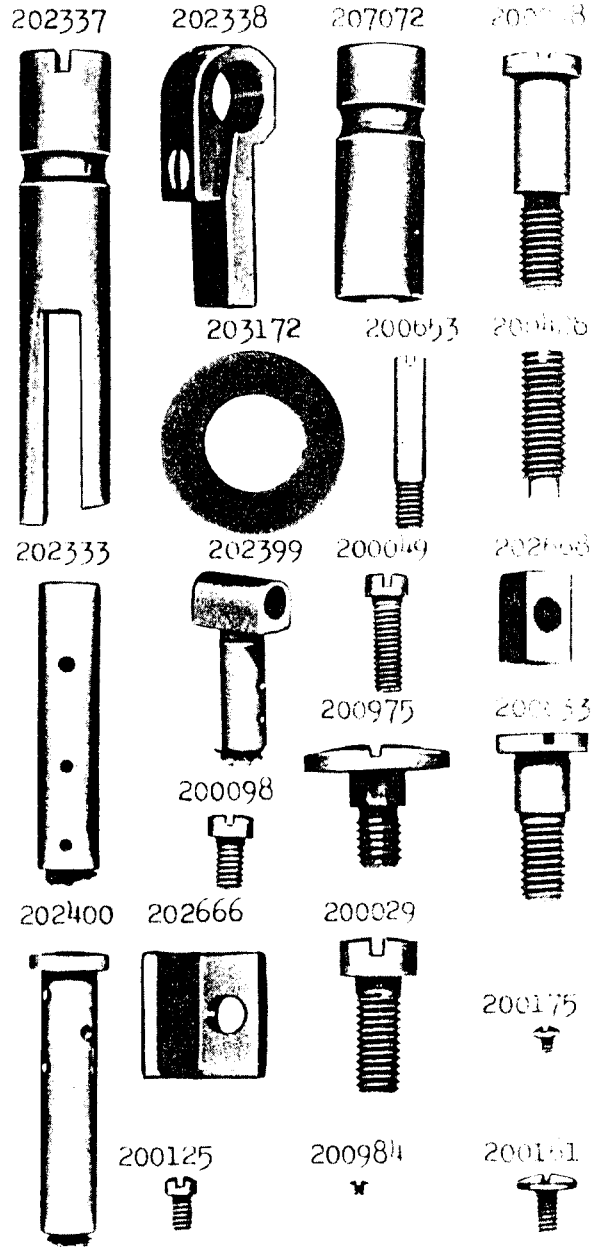


PLATE 16578 - FULL SIZE

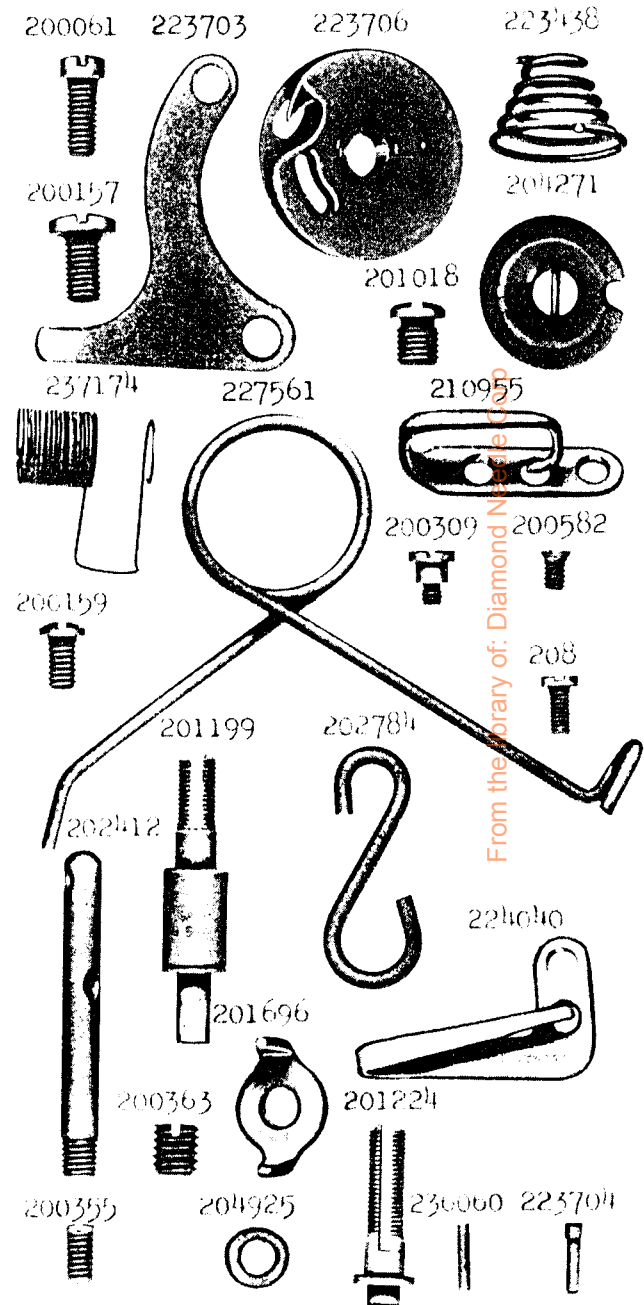


PLATE 16579 - ONE-HALF SIZE

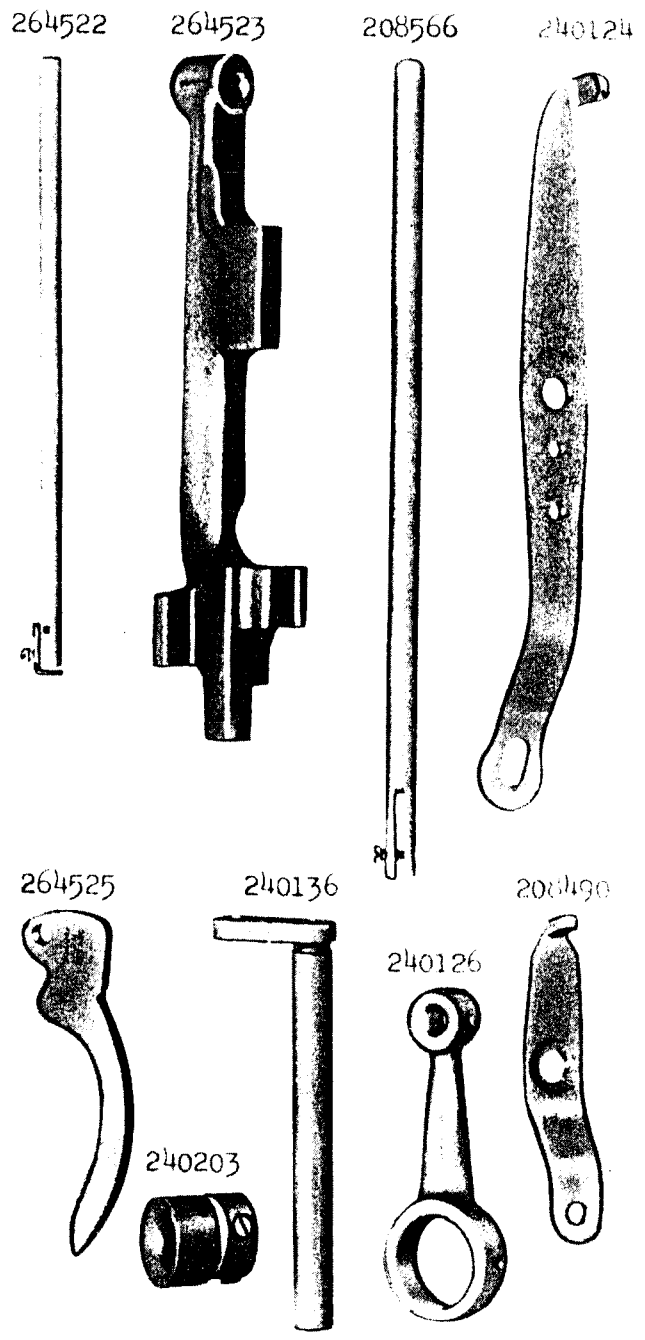


PLATE 16580 - FULL SIZE

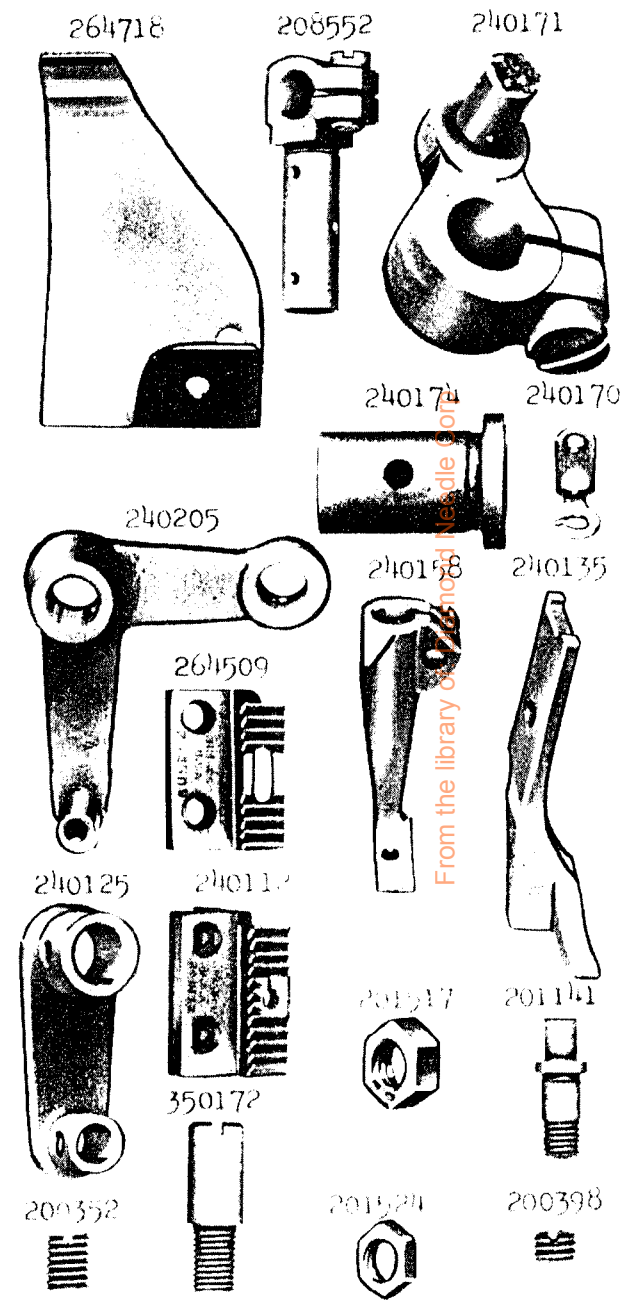


PLATE 16581 - FULL SIZE

